

# **Sonoma**™ PLATINUM EDITION

## **Sonoma Platinum Edition Grill: 27" Model with Rear Infrared Burner**



# **USE AND CARE MANUAL**



**FOR OUTDOOR USE ONLY**

# General Safety Instructions

## IMPORTANT SAFETY INFORMATION



- Read this manual carefully before using your grill to reduce the risk of fire, burn hazard or other injury.
- Extreme care should be used because of the high temperatures produced by this appliance. **CHILDREN SHOULD NOT BE LEFT UNATTENDED IN AN AREA WHERE THE GRILL IS BEING OPERATED.**
- This appliance must be kept clear from combustible materials, gasoline or other flammable vapors and liquids. Do not allow flammable materials to come in contact with grate, burner or hot surfaces.
- Use only outdoors and provide good ventilation to avoid carbon monoxide build-up which could result in injury or death.
- Do not repair or replace any part of this appliance unless it is specifically recommended in this manual. A qualified service technician should conduct all other service.
- Follow the installation and servicing instructions provided with this product. Have your grill installed by a qualified service technician.
- Locate the main gas supply valve so that you know how to shut the gas off to your grill.
- If you smell gas, make sure all gas connections are tight before operation. If you continue to smell gas call a qualified technician.
- When lighting a burner, always pay close attention to what you are doing and be certain you are pushing the igniter that lights the burner you intend on using.
- Always keep your face and body as far away as from the grill as possible when lighting to reduce the risk of burn.
- Extinguish all flames and do not smoke while engaging gas and igniting the grill.

### FOR YOUR SAFETY

If you smell gas:

1. Shut off gas to the appliance.
2. Extinguish any open flames.
3. Open grill hood.
4. If odor continues, immediately call your gas supplier.

### CALIFORNIA PROPOSITION 65 - WARNING:

The Burning of gas cooking fuels generates some by products which are on the list of substances which are known by the State of California to cause cancer or reproductive harm. California law requires businesses to warn customers of potential exposure to such substances. To minimize exposure to these substances, always operate this unit according to the use and care manual, provide good ventilation when cooking with gas.

This appliance is not intended to be installed in or on recreational vehicles or boats.

**FOR OUTDOOR USE ONLY**

**TESTED IN ACCORDANCE WITH ANSI Z21.58b-2002/CGA 1.6b-M02 STANDARD FOR OUTDOOR COOKING GAS APPLIANCES. THIS GRILL IS FOR OUTDOOR USE ONLY.**

Check your local building codes for the proper method of installation. In the absence of local codes, this unit should be installed in accordance with the National Fuel Gas Code No. Z223.1-2002 and the National Electrical Code ANSI/NFPA No. 70-1990

### FOR YOUR SAFETY

**DO NOT** store or use gasoline or other flammable vapors and liquids in the vicinity of this or any other appliance.

An **LP cylinder** not connected for use shall not be stored in the vicinity of this or any other appliance.

### WARNING

**DO NOT** try lighting this appliance without reading the “**LIGHTING INSTRUCTIONS**” section of this manual.

# Grill Features

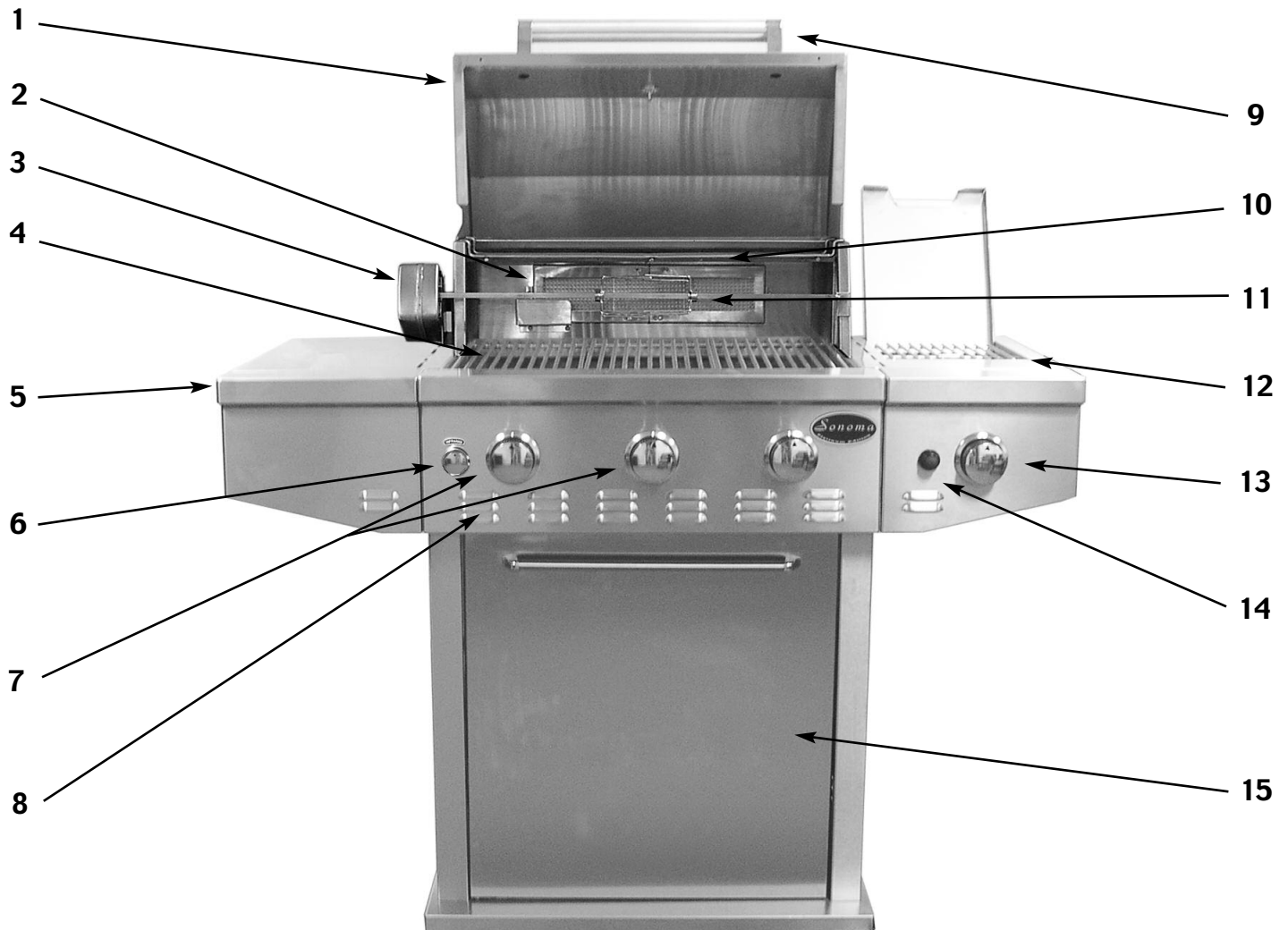

- |                                |  |
|--------------------------------|--|
| 1. Roll top grill hood         | 9. Hood Handle                             |
| 2. Rear Infrared Burner        | 10. Warming shelf                          |
| 3. Rotisserie Motor            | 11. Rotisserie Spit and Forks              |
| 4. Grilling/Cooking surface    | 12. Side Burner                            |
| 5. Side Shelf                  | 13. Control knob: Side Burner              |
| 6. Rear IR control knob        | 14. Electronic igniter: main & side burner |
| 7. Control knobs: main burners | 15. Cart with door                         |
| 8. Convection vents            |  |

# Grill Assembly

**IMPORTANT: Remove all protective plastic film from stainless steel parts prior to assembly/use. This film is installed at the factory to prevent damage that could occur during shipment and handling.**

## LEFT SHELF ASSEMBLY

1. Open the grill hood and place a piece of styrofoam from the packaging under the grill hood to prop the grill hood open slightly. (See Fig. 1)
2. Attach the left shelf by inserting the four shelf hooks into the slots on the side of the grill. (See Fig. 1)
3. After inserting the four shelf hooks, press the shelf against the grill and press downward until the shelf locks in place. Make sure the top strip is hanging all the way inside of the grill before pressing downward. (See Fig. 1)
4. Install one self tapping screw into the bottom front hole of the shelf to lock shelf in place. (See Fig. 2)

## SIDE BURNER PARTS ASSEMBLY

1. Remove side burner assembly from packaging. (See Fig. 3)
2. Place a piece of styrofoam from the packaging in the grill to leave the grill hood propped open slightly. (See Fig. 4)
3. Attach the right side burner by inserting the four shelf hooks into the slots on the side of the grill. (See Fig. 4)
4. After inserting the four shelf hooks, press the side burner shelf against the grill and press downward until the shelf locks in place. Make sure the top strip is hanging all the way inside of the grill before pressing downward. (See Fig. 4)

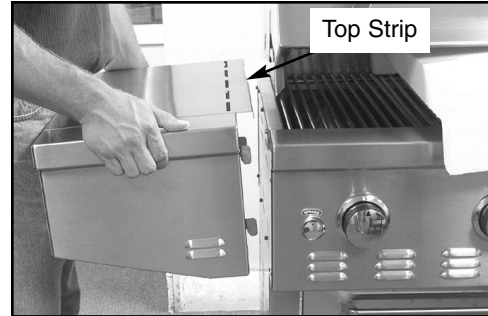

Fig. 1

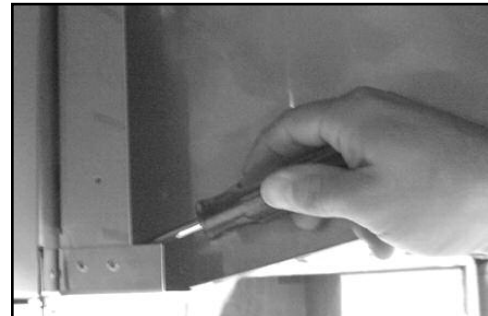

Fig. 2

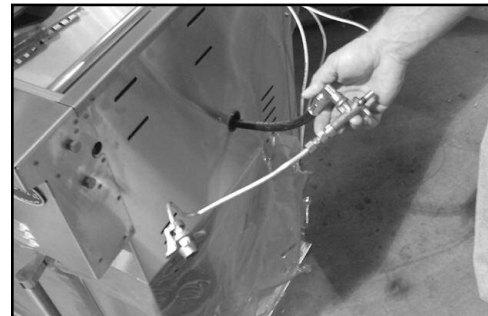

Fig. 3



Fig. 4

# Grill Assembly

5. Slide the valve assembly through the center hole in the front of the shelf. (See Fig. 5)
6. Press the side burner assembly upward into the side burner tray (See Fig. 6) and install two (2) self tapping screws from the top of the tray. (See Fig. 7)
7. Insert one valve screw through the bezel and in to the side burner valve and tighten. Next, install the second valve screw through the bezel and tighten. Make sure the bezel is installed with the "H" facing the igniter hole. (See Fig. 8)
8. Install metal knob, making sure to line up the flat side of the valve stem with the flat side of the knob stem. (See Fig. 9)
9. Install side burner head and cap. (See Fig. 10-11)
10. Install grate over side burner. (See Fig. 12)

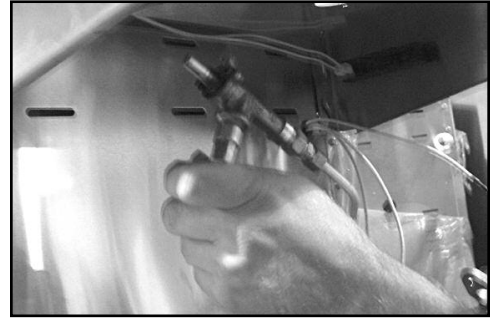

Fig. 5



Fig. 6

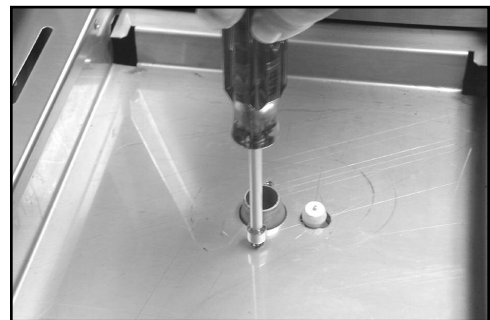

Fig. 7

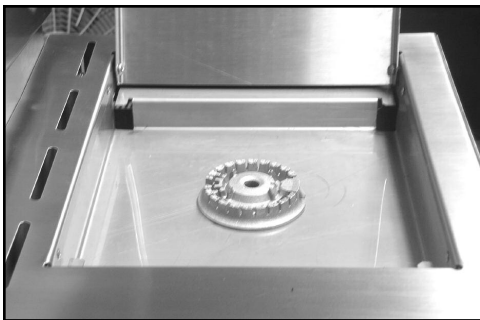

Fig. 10

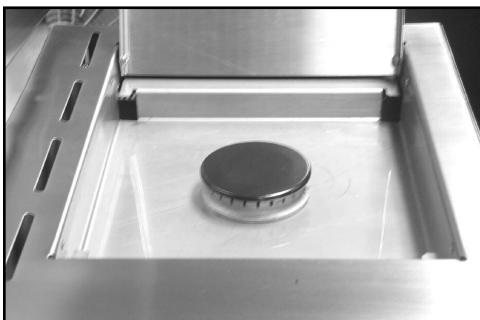

Fig. 11

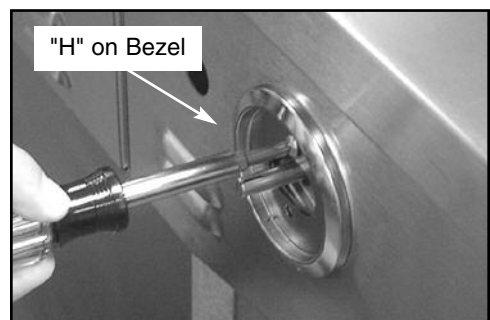

Fig. 8

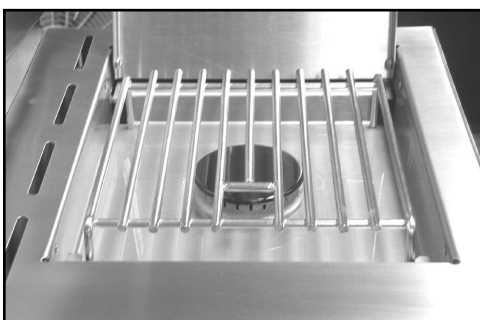

Fig. 12



Fig. 9

# Grill Assembly

## IGNITER ASSEMBLY

1. The battery, spring and igniter cap must be installed before using.
2. Slide the threaded part of the igniter through the mounting bracket and then through the igniter hole in the front of the side burner shelf, then install the locknut. (See Fig. 13)
3. Slide spring assembly over the positive side of the battery. (See Fig. 14)
4. Install the battery, negative side first. (See Fig. 14)
5. Screw igniter cap onto igniter. (See Fig. 15)
6. Attach the large end of the side burner wire to the terminal spade of the side burner electrode. (See Fig. 16)
7. Attach the four (4) wires coming out from the side of the grill and the side burner wire to the igniter terminals. (See Fig. 17)

**NOTE: It does not matter which wire goes to which terminal on the igniter.**

## INTERIOR PARTS ASSEMBLY

1. Insert the top row of flavor grids into the cutouts with triangle ridges facing up. (See Fig. 18)
2. Install cooking grates on the ledges provided on the grill to create your cooking surface. (See Fig. 19)
3. Rest warming shelf on four (4) slots above cooking grid. (See Fig. 19-20)

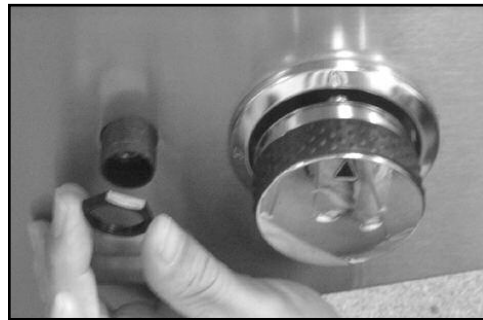

Fig. 13

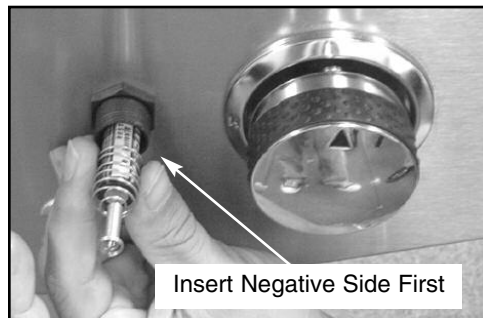

Fig. 14

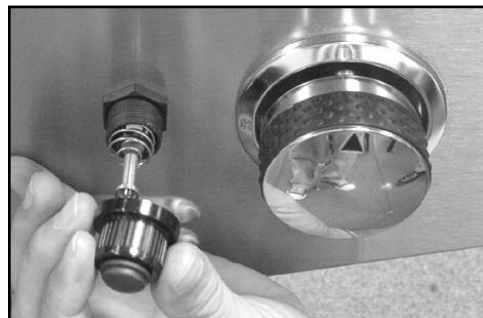

Fig. 15

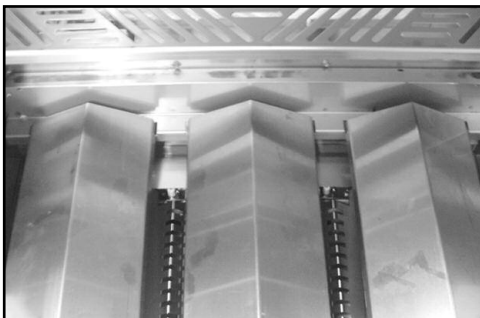

Fig. 18

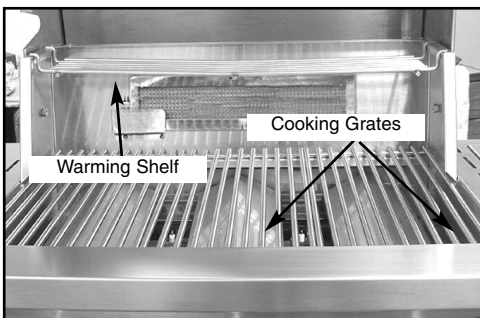

Fig. 19

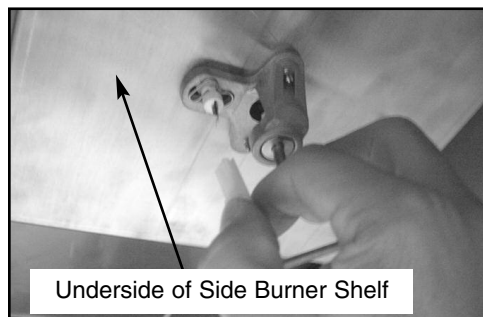

Fig. 16



Fig. 20



Fig. 17

# Gas Requirements

---

## L.P. GAS INSTALLATION

Sonoma Gas Grills are set to operate with L.P. gas and come with a high capacity hose and regulator assembly.

**(Note: Only use the pressure regulator and hose assembly supplied with the grill or a replacement pressure regulator and hose assemblies specified by Sonoma).** This assembly is designed to connect directly to a standard 20 lb. L.P. cylinder. L.P. Cylinders are not included with the grill. L.P. Cylinders can be purchased separately at an independent dealer.

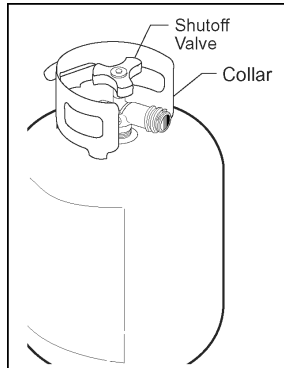

LP hose/  
regulator  
supplied  
(Type 1  
connector)

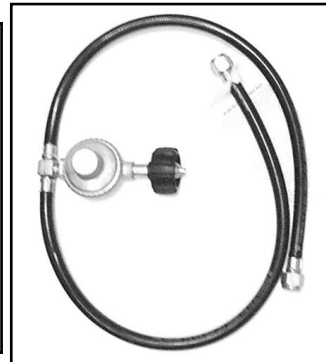

## L.P. TANK INFORMATION

Never use a dented or rusted L.P. tank or cylinder with a damaged valve.

L.P. cylinders are equipped with an O.P.D (Overfilling Prevention Device). The device shuts off the flow of gas to a cylinder after 80% capacity is reached. This limits the potential for release of gas when the cylinder is heated, averting a fire or possible injury.

The L.P. cylinder must have a shut-off valve terminating in an L.P. gas supply cylinder outlet specified, as applicable, for connection No. 510 in the standard for compressed gas cylinder valve outlet and inlet connection ANSI/CGA-V-1. Cylinders must not be stored in a building, garage, or any other enclosed area. (The L.P. cylinder must have an overfill protection device, OPD, on it.)

The L.P. gas supply cylinder must be constructed and marked in accordance with the specifications for L.P. gas cylinders of the U.S. Department of Transportation (DOT) or the National Standard of Canada, CAN/CAS-B339, "Cylinders, Spheres and Tubes for the Transportation of Dangerous Goods."

## L.P. TANK USE

- **When turning the L.P. tank on, make sure to open the valve SLOWLY two (2) complete turns to insure proper gas flow. Most gas tanks now come equipped with a leak detector mechanism internal to the tank, when gas is allowed to escape rapidly it shuts off the gas supply. Opening the valve rapidly may simulate a gas leak, causing the safety device to activate, restricting gas flow causing low flames. Opening the valve slowly will insure this safety feature is not falsely triggered.**
- When not in use, gas supply cylinder valve is to be in the "OFF" position.
- The tank supply system must be stored upright to allow for vapor withdrawal.
- The regulator and hose assembly must be inspected before each use of the grill. If there is excessive abrasion or wear or if the hose is cut, it must be replaced prior to the grill being used again.
- Cylinders must be stored outdoors out of the reach of children and must not be stored in a building, garage or any other enclosed area.
- Only a qualified gas supplier should refill the L.P. tank.
- Do not store a spare L.P. gas cylinder under or near the grill.

# Pre Operation Leak Testing

---

## **GENERAL INFORMATION**

Although all gas connections on the grill are leak tested prior to shipment, a complete gas tightness check must be performed at the installation site due to possible shifting during shipment, installation or excessive pressure unknowingly being applied to the unit. Periodically check the whole system for leaks and immediately check the system if the smell of gas is detected.

## **BEFORE TESTING**

Do not smoke while leak testing. Extinguish all open flames. Never leak test with an open flame.

Mix a solution of equal parts mild detergent or liquid soap and water.

## **TESTING**

1. Turn off the burner control knobs.
2. Turn the top knob of the fuel supply cylinder counterclockwise (right to left) two (2) rotations to open.
3. Apply the soap solution to connections of the fuel supply assembly. If no soap bubbles appear, there is no gas leak. If bubbles form at the connections, a leak is detected. If a leak is detected, immediately turn off the gas supply, tighten any leaking fittings, turn gas on, and repeat steps 1-3.
4. Turn off the knob on the fuel supply cylinder.
5. Turn on the burner control knobs for a moment to release the pressure in the hose, then turn the control knobs back off.
6. Wash off soapy solution with cold water and towel dry.

Check all gas supply fittings before each use and each time the gas supply cylinder is connected to the regulator. Have a qualified service technician leak test the grill any time a part of the gas system is replaced.

Also it is recommended to perform a leak test at least once a year whether or not the L.P. gas supply cylinder has been disconnected.

**NOTE: When leak testing this appliance, make sure to test and tighten all loose connections, including the side burner. A slight leak in the system can result in a low flame, or hazardous condition. Most L.P. gas tanks now come equipped with a leak detector mechanism internal to the tank, when gas is allowed to escape rapidly, it shuts off the gas supply. A leak may significantly reduce the gas flow making the grill difficult to light or causing low flames.**

**NOTE: If you cannot stop a gas leak turn off the gas supply and call your local gas or the dealer you purchased the appliance from. If necessary, replace the faulty part with the manufacturer's recommended replacement part. A slight leak could cause a fire.**

# Lighting the Grill

**Do not attempt to “Light” the grill if the odor of gas is present!!**

## BEFORE LIGHTING

**⚠ WARNING** Important! Before Lighting:

- Check the gas supply line for cuts, wear or abrasion.
- Always keep your face and body as far away from the grill as possible when lighting.

## GRILL BURNER LIGHTING

### Lighting the Grill with electronic igniter

1. Make sure all control knobs are in the “OFF” position.
2. Open the gas supply valve located on top of your L.P. tank.

**ATTENTION:** When turning the L.P. tank on, make sure to open the valve very **SLOWLY** two (2) complete turns to insure proper gas flow.

3. Always open the hood before attempting to light.
4. Push and turn one of the control knobs counter clockwise to the “HIGH” position and immediately press the electronic igniter button. You will hear a snapping sound. It may be necessary to hold the electronic starter button for about 4 seconds. (See Fig. 21)

**NOTE:** If the burner does not light in 4 seconds, turn the knob to the “OFF” position and wait 5 minutes before trying again.

5. Repeat above steps to light remaining burners.

### Match Lighting

If by chance the electronic igniter does not light the burner, the burner may be lit with a match attached to the match extender, located on the inside of the cart door.

Keep your face as far away from the grill surface as possible and pass the match extender through the spaces in the grill grates to the ports of the back crossover burner between the flavor grids. Position the match near the burner ports and push and turn the control knob counter clockwise to the “HIGH” position. (See Fig. 22-23)

The match extender can be stored inside the cart door by sliding the extender ring through the opening on the inside, back of the cart door. (See Fig. 24-25)

**NOTE:** If the grill will not light after several attempts see the trouble-shooting section of this manual. Turn the control knobs to the OFF position when not in use.



Fig. 21

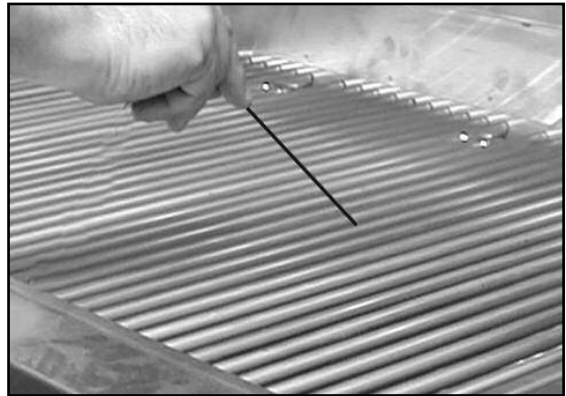

Fig. 22

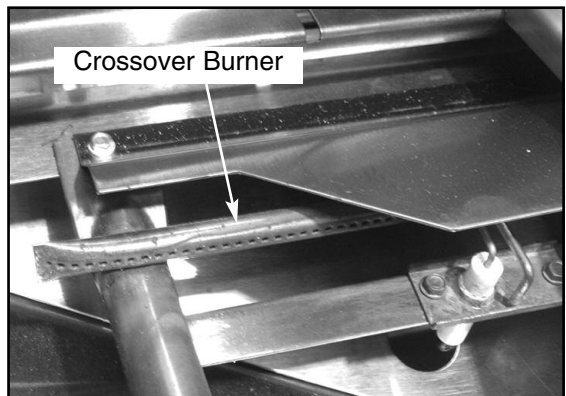

Fig. 23



Fig. 24

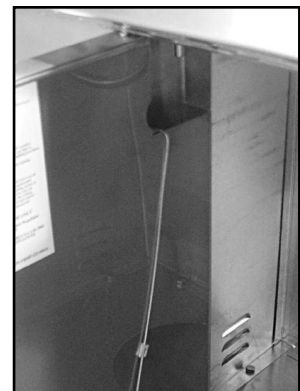

Fig. 25

# Using the Grill and Side Burner

## **GRILL LOCATION**

### **⚠ WARNING**

Do not use the grill in garages, breezeways, sheds or any enclosed area. Never operate the grill in enclosed areas as this could lead to a carbon monoxide buildup, which could result in injury or death. Place the grill on a level surface. Avoid moving the grill while it is operation.

**NOTE: The grill will operate best if it is not facing directly into the wind.**

Clearance to combustible construction - A minimum of 13" from the sides and back must be maintained from the gas grill above and below the cooking surface to adjacent vertical combustible construction.

Clearance to non-combustible construction - A minimum of 6" clearance from the back of the grill to non-combustible construction is required for the lid to fully open.

Storage of an outdoor gas cooking appliance indoor is permissible only if the cylinder is disconnected and removed from the appliance.

## **GENERAL RULES**

**Do not leave the grill unattended while cooking!**

1. Make sure the grill has been leak tested and is properly located.
2. Light the grill burners using the instructions provided in this manual.
3. Turn the control knobs to desired temperature "High, Medium, or Low" and preheat the grill for 10 minutes before cooking.
4. Adjust heat settings to meet your cooking needs for desired results.
5. Allow grill to cool down, wipe off any splatters or grease and clean the drip tray as needed.
6. Do not put a cover on the grill while it is still hot as it could start a fire.



**Keep any electrical supply cords and the fuel supply hose away from any heated surfaces.**

## **SIDE BURNER LIGHTING**

Push and turn the control knob to the "HIGH" position and immediately press and hold the electronic igniter button. You'll hear a snapping sound. It may be necessary to hold the electronic starter button for about 4 seconds. If the burner does not light in 4 seconds, turn the knob to the "OFF" position and wait 5 minutes before trying again. (See Fig. 26)

## **MATCH LIGHTING**

If by chance the electronic igniter does not light the burner, the burner may be lit with a match. Attach the match to the match extender, located inside the right cart door.

Keep your face as far away from the grill surface as possible and hold a match, attached to the match extender, near the burner ports, then push and turn the control knob counter clockwise to the "HIGH" position.



**Fig. 26**

# Using the Rotisserie Burner

The grill rotisserie system is designed to cook items from the back using infrared heat. The rotisserie burner is an infrared type which provides intense searing radiant heat. Preferred by chefs over other cooking methods, this intense heat sears in the natural juices and nutrients found in quality cuts of meats.

**Remove the warming rack from the grill when using the rotisserie to prevent warping from the intense heat of the infrared unit.**

**NOTE: The rotisserie spit rod is centered between the grill hood and the burners. It may be necessary to remove the grates and flavor grids when cooking larger portions of meat on the rotisserie. This is by design, since this configuration gives you the most possible room above and below the rod for larger pieces of meat.**

Once lit, the rotisserie burner will reach cooking temperature in 1 minute. The orange/red glow will even out in about 5 minutes. The rotisserie motor is equipped with metal gears and is capable of turning up to 12 lbs. of food. The motor is mounted on a bracket on the left side of the grill by sliding the motor over the bracket with the cord facing the back of the grill. Make sure the rotisserie motor is completely seated on the bracket prior to operating. Make sure the rotisserie cord is away from any hot surfaces.

## **⚠ WARNING Electrical Grounding Instructions**

**This appliance (rotisserie motor) is equipped with a three-prong (grounding) plug for your protection against shock hazard and should be plugged directly into a properly grounded three-prong receptacle. Do not cut or remove the grounding prong from this plug.**

### **ATTACHING THE ROTISSERIE**

The motor is mounted on a bracket on the left side of the grill by sliding the motor over the bracket with the cord facing the back of the grill. (See Fig. 27)

With the rotisserie motor in place and plugged into an electrical outlet, it is now ready to operate. Slide one of the meat forks onto the rod (prongs facing away from the rounded end). Push the rod through the center of the food, then slide the second meat fork onto the rod (prongs toward the food). Center the food to be cooked on the rod, then push the meat forks firmly together. Tighten the thumb screws. It may also be necessary to wrap food with butcher's string, (never use nylon or plastic string) to secure loose portions. (See Fig. 28)

Once the food is secure, insert the pointed end of the rotisserie rod into the motor assembly and rest the other end on the support on the right-hand side of the grill. (If needed, remove the cooking grates for more room). Turn the power switch to the "On" position to start the rotisserie motor.

**NOTE: Remove the rotisserie when not in use. Store the unit indoors when not in use. Remove warming shelf when using rotisserie.**

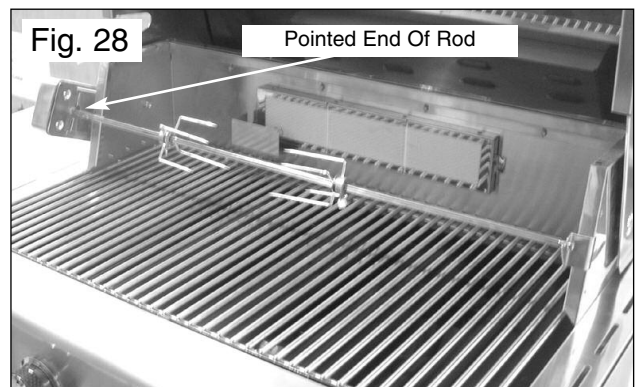

**⚠ WARNING Do not use the rotisserie in the rain.**

# Rotisserie Lighting/ Care and Maintenance

## ROTISSERIE LIGHTING

Open the lid. Push and turn the control knob for the rotisserie counter clockwise to the "HIGH" position.

**Wait 5 seconds.** Then press and hold the electronic igniter button. You'll hear a snapping sound. If the burner does not light in 4 seconds, turn the control knob to OFF and wait 5 minutes before trying again. Once lit, turn the control knob to the desired setting. (See Fig. 29)

If the igniter does not function, the burner can be lit by holding a lit match to the burner while the control knob is turned counter clockwise to "HIGH". (See Fig. 30)

**NOTE: After the first use the stainless steel around the burner will darken. This is a normal reaction of premium stainless steel to heat and is not a defect. The infrared panel will also darken after initial use. This is also a normal occurrence.**

 **NOTE: Do Not operate the main burners and infrared back burner at the same time. This can cause warping of the roll top grill hood.**

## DRIP TRAY

The drip tray should be cleaned periodically to prevent heavy buildup of debris.

**NOTE: Allow the drip tray to cool before attempting to clean.**

**Important: Do not leave the grill outside during inclement weather unless it is covered. Rain water can collect inside of the grill, the grill cart or the drip tray if left uncovered. If the drip tray is not cleaned after use and the grill is left uncovered, the drip tray will fill with water causing grease and water to spill into the grill cart. We recommend cleaning and storing the drip tray after every use.**

## COOKING GRATES

The cooking grates can be cleaned immediately after cooking is completed and after turning off the grill. Wear a barbecue mitt and scrub the cooking grates with a damp cloth. If the grill is allowed to cool down, cleaning the grates will be easier if removed from the grill and cleaned with a mild detergent.

## STAINLESS STEEL

After initial usage, areas of the grill may discolor from the intense heat given off by the burners, this is normal.

Purchase a mild stainless steel cleaner and rub in the direction of the grain of the metal. Specks of grease can gather on the surface of the stainless steel and bake on to the surface and give a worn appearance. For removal, use a non-abrasive oven cleaner in conjunction with a stainless cleaner.

**NOTE: Always scrub in the direction of the grain.**

## IGNITER ACCESS (UNDER SIDE BURNER SHELF)

To remove igniter, unscrew igniter push button and locking nut from front panel of the side burner and igniter will fall out through the bottom



# Troubleshooting Your Grill

---

## **GENERAL TROUBLE SHOOTING**

You should inspect the burners at least once a year or immediately if any of the following conditions occur:

- The smell of gas.
- Flames appearing mostly yellow. (some yellow at the tips is OK)
- The grill will not get hot enough.
- Burners make a snapping noise.
- The grill heats unevenly.

## **SPIDER AND INSECT WARNING**

Spider and insects can nest in the burners of this or any other grill and cause the gas to flow from the front of the burner. This is very dangerous condition which can cause a fire to occur behind the valve panel, thereby damaging the grill and making it unsafe to operate. We recommend you check the grill and remove any spiders, insects and webs at least once a year to reduce this risk.

## **BEFORE CALLING CUSTOMER SERVICE**

If the grill does not function properly, use the following checklist.

### **PROBLEM**

### **SOLUTION**

**Grill will not light when the igniter button is pushed.**

Is your gas supply turned on?

Is there gas in your L.P. tank? Check your gas level.

Is one of your burners turned on? Allow up to four seconds of gas flow to ignite.

Is your igniter working?

- You should hear a snapping sound when you press the igniter?

- If you hear a snapping sound can you see a spark at the electrodes?

**Note - You will need to remove your cooking grates and flavor grids to see the electrodes.**

Check to see if your igniter battery is installed correctly with the **negative** side first.

Check your igniter battery and replace if needed.

Check for loose wire connections to the igniter or electrodes.

Check to see if debris is blocking the electrodes.

If the igniter is not working can you light the grill with a match?

# Troubleshooting Your Grill

---

## PROBLEM

## SOLUTION

---

**Grill will not light with a match or low heat with dial set to "High" position.**

- Is your gas supply fully turned on?
- Is there gas in your L.P. tank? Check your gas level.
- Shut off gas supply, disconnect gas line at tank, reconnect the line to the tank.
- Make sure all the knobs are in the off position, then open the gas supply valve on the L.P. tank very slowly 1/4 turn, then open fully (at least two full turns). Check flame height again.
- Check to insure the gas supply line or hose is not kinked.
- If only one burner appears low, check and clean the burner ports if clogged or dirty.
- Check for leaks.

**Note - Pre-Heating time can take from 5 to 10 minutes.**

---

**Flame is erratic**

- Check gas connection
    - look for kinked hose.
    - make sure gas supply valve is fully open.
  - Gas level may be low.
  - Grill may be in need of cleaning.
- 

**Flare-ups**

- Check flavor grids and cooking grates for excess food or grease build-up.
- Ensure grill is not placed directly in the path of wind.
- Be sure drip tray is clean, (do not use aluminum foil on drip tray.)

**Note: Some flare-ups may be inevitable if cooking greasy foods.**

---

**Burner flame is mostly yellow or orange, possibly in conjunction with smell of gas.**

- Check the burner inlet for obstructions. Particularly at air inlets for each burner.
- Grill may be in an area that is too windy.



# Warranty

## LIMITED LIFETIME WARRANTY

Sonoma warrants this grill to the original purchaser of our grills when subject to normal residential use to be free from defects in workmanship and materials for the periods listed below.

**IMPORTANT:** We recommend you return the warranty registration card so that you can be contacted with any questions of safety arise that could affect you. The return of the warranty registration card is not a condition for warranty coverage.

### LIMITED WARRANTY

Component	Warranty Period
Stainless Steel Panels:	Limited Lifetime
Burners:	Limited 4 Years
Valves, Knobs, Electronic Igniter, Other related parts	Limited 1 Year

If the Sonoma Platinum Edition Grill does not operate properly, first thoroughly carry out the instructions provided with the unit to ensure that the appliance is installed correctly and check the troubleshooting section in the use and care manual.

- The warranty is non-transferable.
- The warranty is for replacement of defective parts only. Sonoma will not be responsible for damage resulting from accident, alteration, misuse, abuse, hostile environments, improper installation or installation not in accordance with local codes.
- This limited warranty does not cover corrosion or discoloring due to lack of maintenance, misuse, hostile environments, alterations, accidents or abuse or neglect.
- This limited warranty does not cover any scratches, dents, corrosion or discoloring by heat, abrasive and chemical cleaners nor any components used in the installation of the appliance.

Because of continuing product improvement these specifications are subject to change without notice.

**If you have other questions, please contact Customer Service Hotline  
(800) 229-5647**