

# Sonoma™

PLATINUM EDITION

## 27" Natural Gas Conversion Manual

### FOR OUTDOOR USE ONLY

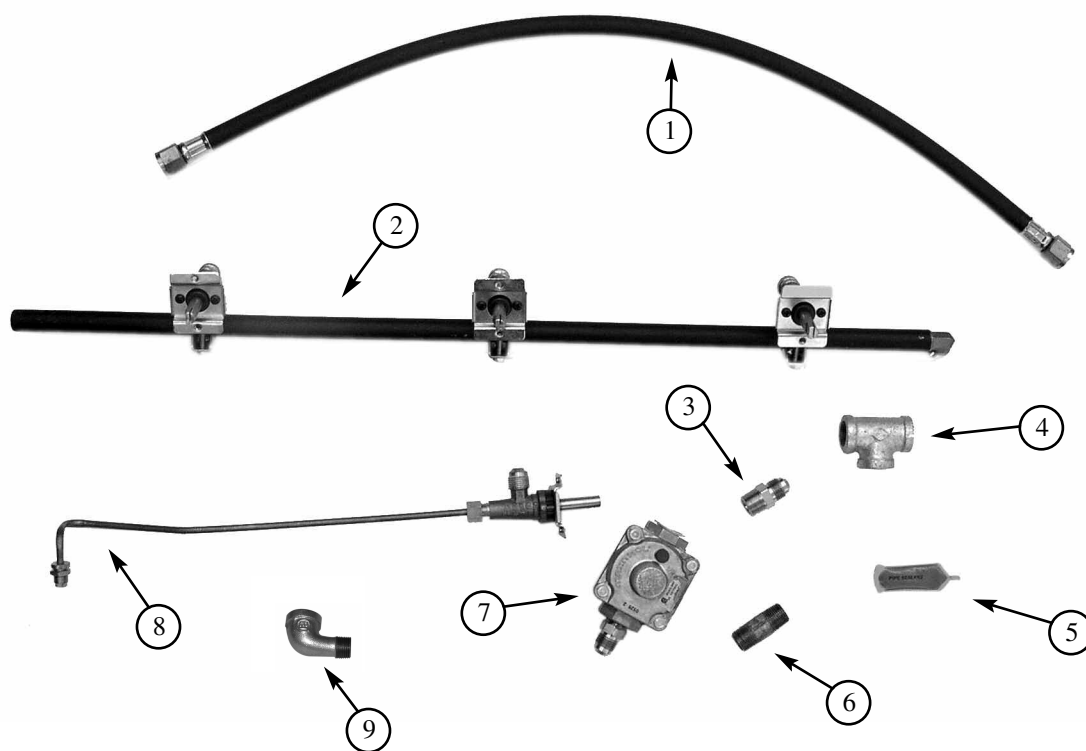

	<b>Part No.</b>	<b>Qty</b>	<b>Description</b>
1	44213827	1	Hose 27" - 3/8" Flare Both Ends for Side Burner (NG)
2	40275101	1	Main Burner Valve & Manifold Assembly with Valves (NG)
3	44110102	2	Connector 3/8" MNPT x 3/8" Flare
4	44133801	1	Tee Fitting - Galvanized 3/8" Flare
5	49900004	1	Sealant Pipe (4ml)
6	44183815	1	Nipple Pipe 3/8" NPT x 1.5"
7	47311010	1	Regulator 3/8" FNPT Threads (NG)
8	46210102	1	Side Burner Valve Assembly - 12K BTU (NG)
9	08338381	1	3/8" Street Elbow



# SGR27 Natural Gas Conversion Instructions

## Tools Needed:

Phillips head screwdriver  
1/4" nut driver \*  
Adjustable wrench

\* 1/4" socket set with extension can also be used.

Be sure gas supply is off, the knobs are in the off position and the grill is cool.

1. Remove cooking grates and flavor grids. (See Fig. 1)
2. Remove the screws holding the rear heat shield in place. Lift out rear heat shield and set aside. (See Fig. 2)
3. Remove the two screws holding each igniter in place. (See Fig. 3)
4. Lay igniters on floor of grill. (See Fig. 4)
5. Loosen the four (4) screws from the bottom of the heat shield, holding the front heat shield in place. The screws are located under the bottom lip of the shield. (See Fig. 5)
6. Loosen the two (2) side heat shield screws located under the bottom lip of the heat shield. There is one screw on each side. (See Fig. 6)

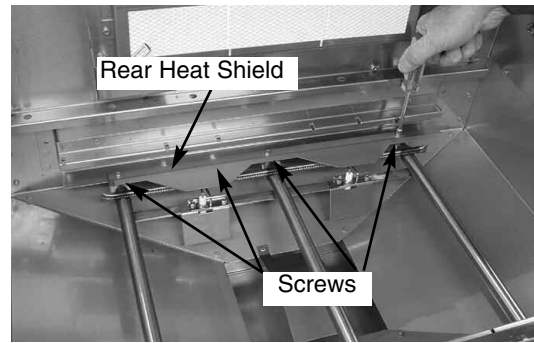

Fig 2

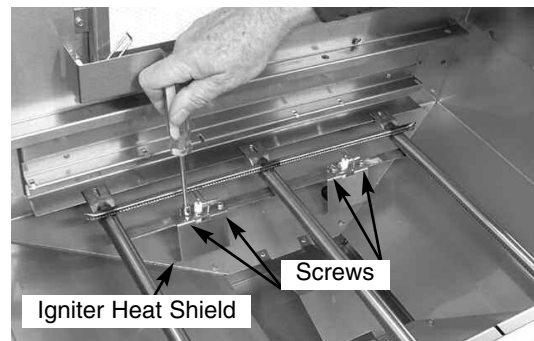

Fig 3



Fig 4

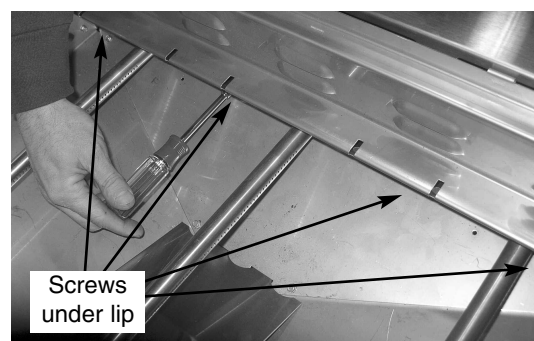

Fig 5

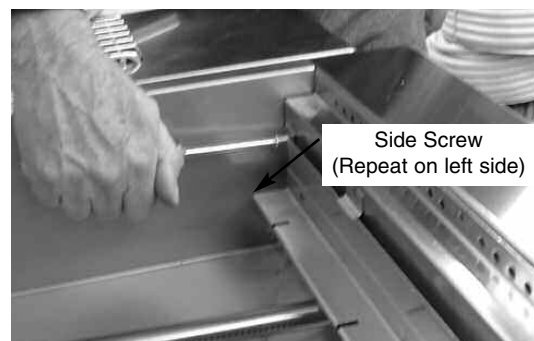

Fig 6

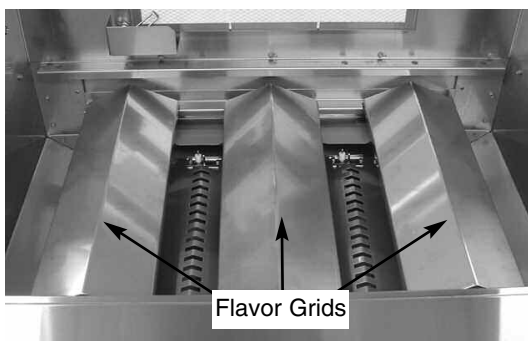

Fig 1

# SGR27 Natural Gas Conversion Instructions

7. Remove the front heat shield. (See Fig. 7)
8. Grasp and push the burner(s) towards the rear of the grill to detach the burner from the valves. (See Fig. 8)
9. Angle the burners up and remove. (See Fig. 8)
10. Remove the control knobs from the front of the grill. (See Fig. 9)
11. Remove the two (2) screws holding each bezel in place on the control panel. (See Fig. 10)
12. Remove the bezels from the front control panel. Note: The small bezel stays in place. (See Fig. 11)
13. Disconnect the right side flex line from the manifold using the adjustable wrench. This will free up the right side of the manifold. (See Fig. 12)
14. Remove manifold from grill body. (See Fig. 13)



Fig 9

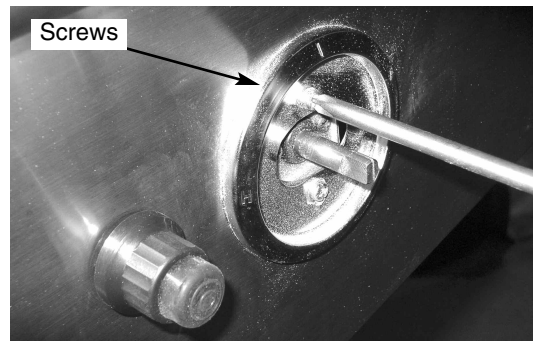

Fig 10

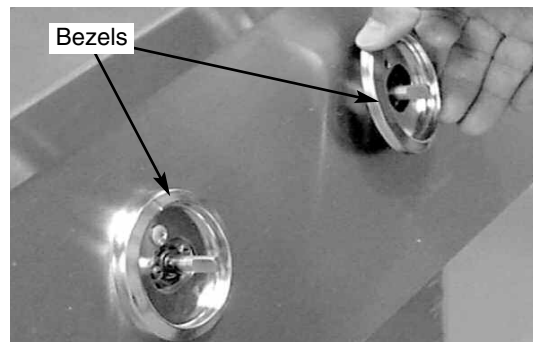

Fig 11

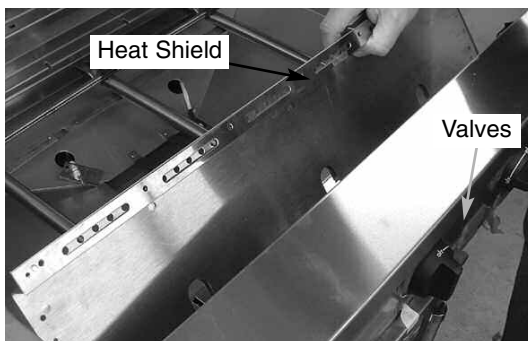

Fig 7

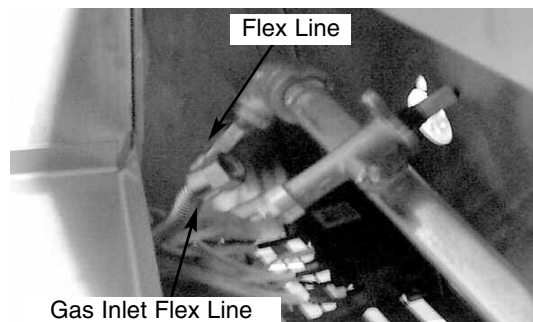

Fig 12

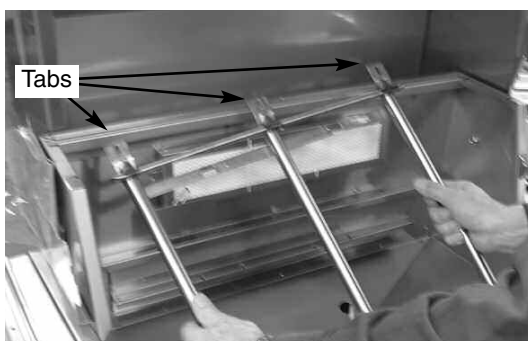

Fig 8

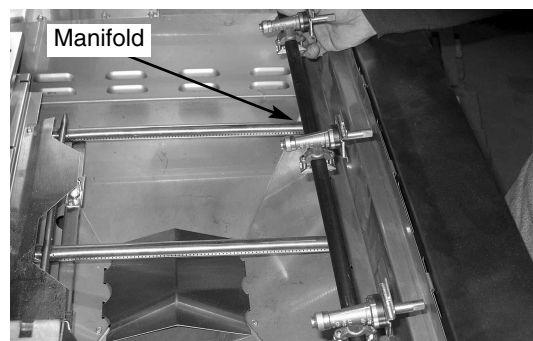

Fig 13

# SGR27 Natural Gas Conversion Instructions

**You are now ready to install the new NG manifold.**

15. Start by placing the new manifold into the grill body with the control knob stems going outward through control panel front. (See Fig. 14)
16. Reattach the flex line on the right of the grill to the new manifold using the adjustable wrench. (See Fig. 12 on previous page)
17. Reattach the bezels to the manifold with the two (2) screws removed in Step 13. Make sure that “off” is facing up on the bezel. (See Fig. 10 & 11)
18. Reattach the control knobs onto the manifold stems, making sure the arrow is facing upwards. (See Fig. 9 on previous page)
19. Reinstall burners into the grill body. Line up the burners with the valves on the manifold, making sure they are level. (See Fig. 15 & 16)
20. Reattach the igniters and their heat shields, removed in Step Four (4), to the burners. (See Fig. 3, on page 2)
21. Reattach the rear heat shield before attaching the front heat shield to be sure the burners remain over the valves. (See Fig. 17)
22. At this point of the conversion, a leak test should be performed on all fittings. See Use and Care manual for leak testing procedure.
23. Proceed with reattaching the front heat shield. (See Fig. 5 and 6 on page 2, and Fig 7 on previous page)
24. Reinstall the flavor grids. (See Fig. 1 on page 2)
25. Reinstall the cooking grates

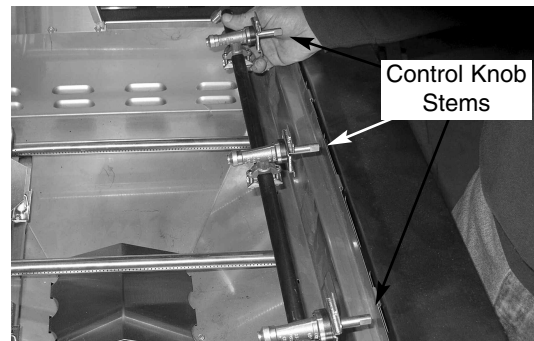

Fig 14

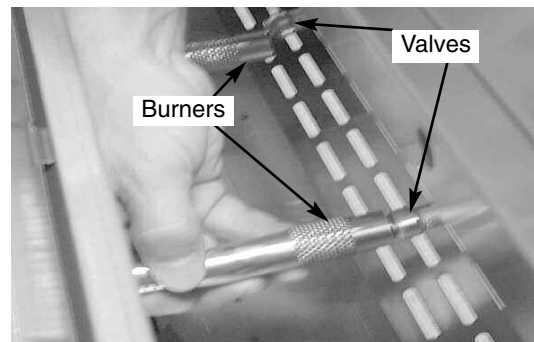

Fig 15

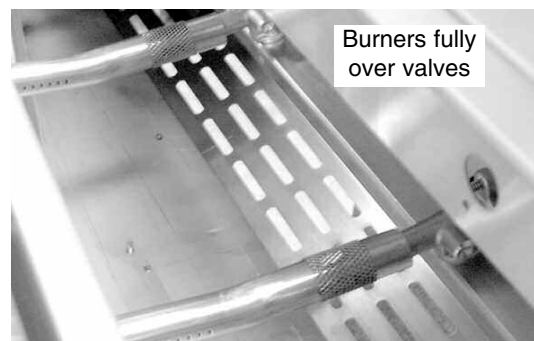

Fig 16

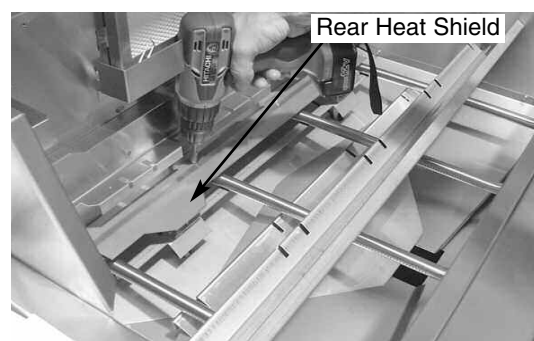

Fig 17

# SGR27 Natural Gas Conversion Instructions

## Installing the NG regulator

1. Remove the LP regulator from the main gas pipe using an adjustable wrench. Located inside the cart on bottom of grill head. (See Fig. 18)

Remaining end still connected will be removed later.

2. Remove the LP nipple brass fitting from main gas pipe. (See Fig. 19)

**Note: For the following steps, the supplied pipe dope needs to be applied to all indicated fittings before the fittings are screwed in.**

**Pipe dope should not be used on any flared fittings!**

3. Remove the grommet in the side of the cart by pressing in on the side with your fingers. (See Fig. 20)
4. Attach the "T" fitting to the main gas pipe as shown. Tighten with wrench. (See Fig. 21)

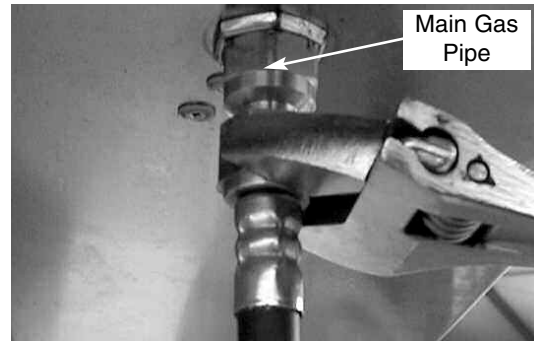

Fig 18

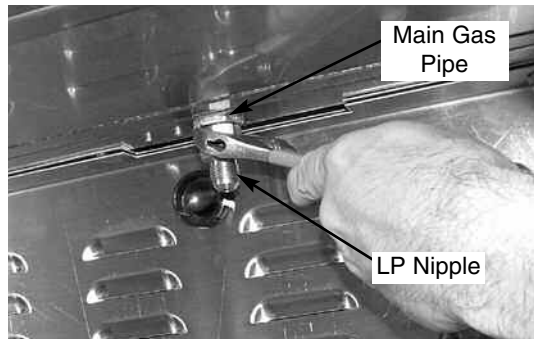

Fig 19



Fig 20

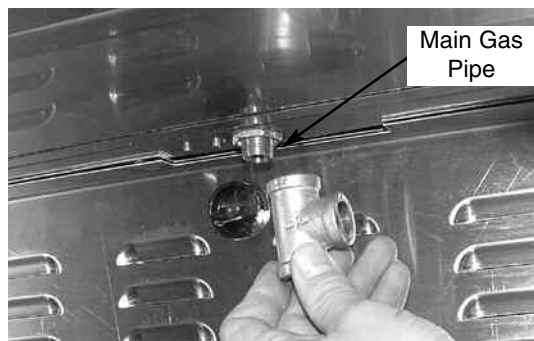

Fig 21

# SGR27 Natural Gas Conversion Instructions

5. Attach the 3/8" to flared fitting to the "T" fitting as shown. Remember to apply pipe dope to the non-flared end. Tighten with wrench. (See Fig. 22)

6. Attach the 3/8" street elbow to the bottom of the "T" connector (See Fig. 23)

7. Attach the 3/8" nipple to the 3/8" street elbow. (See Fig. 24)

8. Attach the NG regulator to the nipple (See Fig. 25).

**Note: pay attention to arrow on the NG regulator indicating direction of gas flow. The arrow should point toward the grill.**

**Remember to apply pipe dope!**

9. Attach one end of the supplied hose to the flared fitting on the side of the "T" connector. (See Fig. 26)

The other end of the hose will be attached to the side burner later.

10. Replace the grommet in the side of the cart by pressing with your fingers. (See Fig. 27)

**This completes the NG regulator installation.**

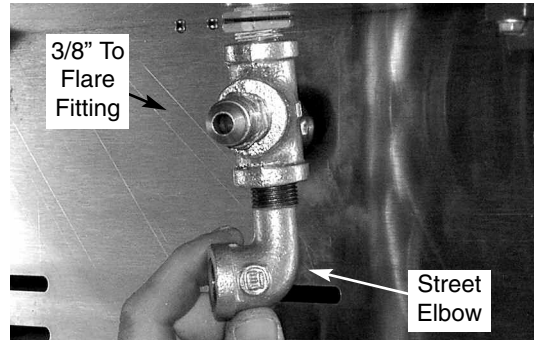

Fig 23



Fig 24

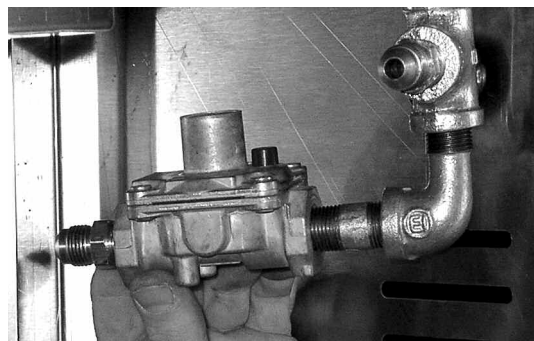

Fig 25

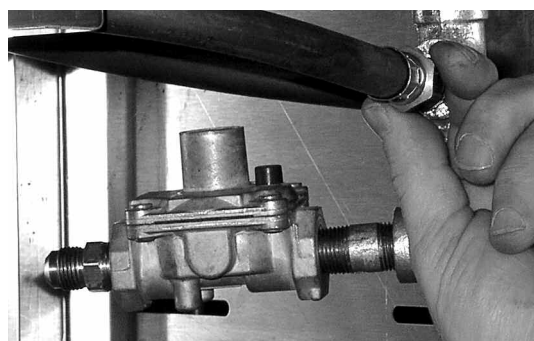

Fig 26



Fig 22



Fig 27

# SGR27 Natural Gas Conversion Instructions

## Converting the Side Burner to NG

1. Remove side burner grate, porcelain cap and burner head. (See Fig. 28)
2. Remove the LP regulator hose attached to the side burner LP valve assembly. (Located on the under side of the side burner.) (See Fig. 29)
3. Remove the control knob from the front of the side burner. (It should pull off by hand.) (See Fig. 30)
4. Remove the two (2) screws holding the bezel and valve in place. Remove bezel from the front of the side burner. (See Fig. 31)
5. Remove the two (2) screws holding the side burner LP valve assembly in place. This will free up the assembly. (See Fig. 32)



Fig 28

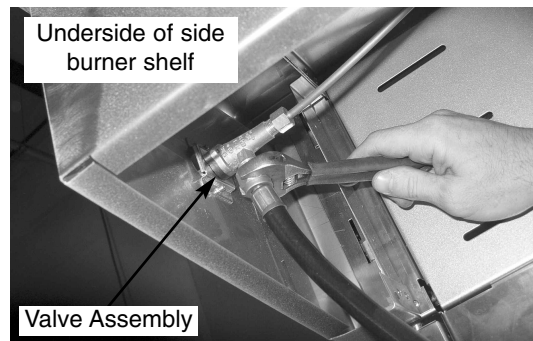

Fig 29



Fig 30

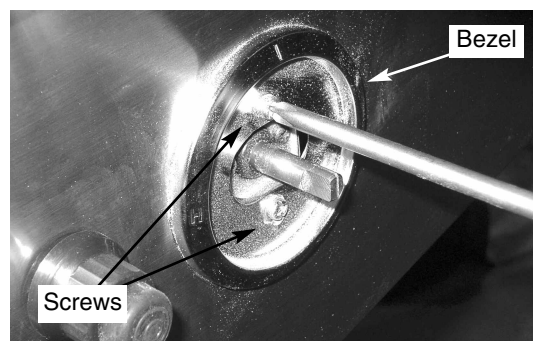

Fig 31

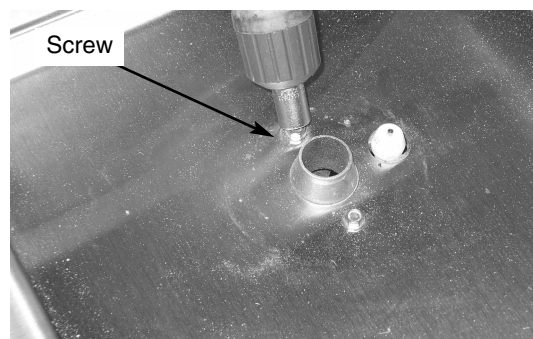

Fig 32

# SGR27 Natural Gas Conversion Instructions

6. Install the NG valve assembly to the under side of the side burner with the two (2) screws previously removed. (See Fig. 33).

**Note: Make sure the NG valve is facing towards the front of the side burner and the valve stem is inserted into the hole.**

7. Reattach the bezel to the front of the side burner and the NG valve with the two (2) screws previously removed. (See Fig. 34).

**Note: Make sure the bezel is installed in the correct position. The “H” will be facing the igniter.**

8. Reattach the control knob.
9. Carefully run the supplied hose from the inside of the cart through the grommeted hole in the cart to the side burner assembly.
10. Connect the end of the new gas supply hose to the NG valve assembly. (See Fig. 35).

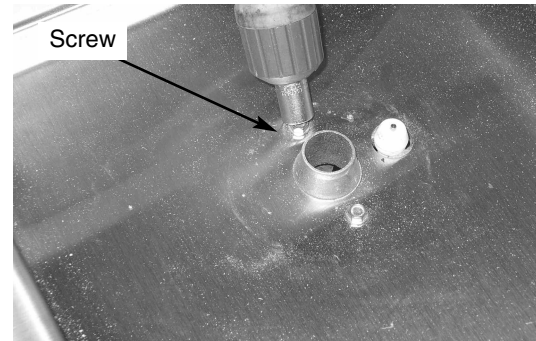

Fig 33

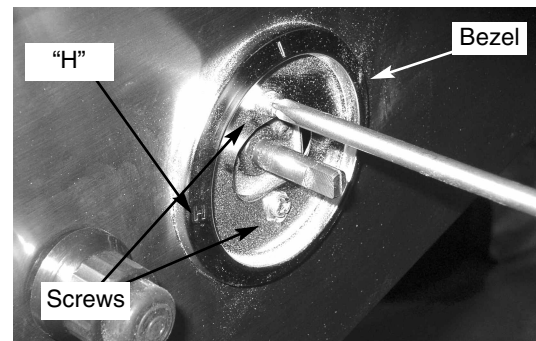

Fig 34

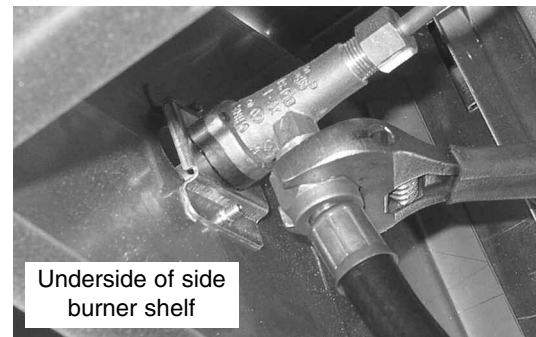

Fig 35

**This completes the side burner conversion.**

**Note: At the completion of the conversion, a leak test should be performed on all fittings. See Use and Care manual for leak testing procedure.**

**Installation is now complete.  
Enjoy your grill safely.**