

# T H E S A V A N N A H S E R I E S

VENT FREE UNIVERSAL FIREBOX

MODEL NUMBERS VFLB32 VFLB36 VFLB42

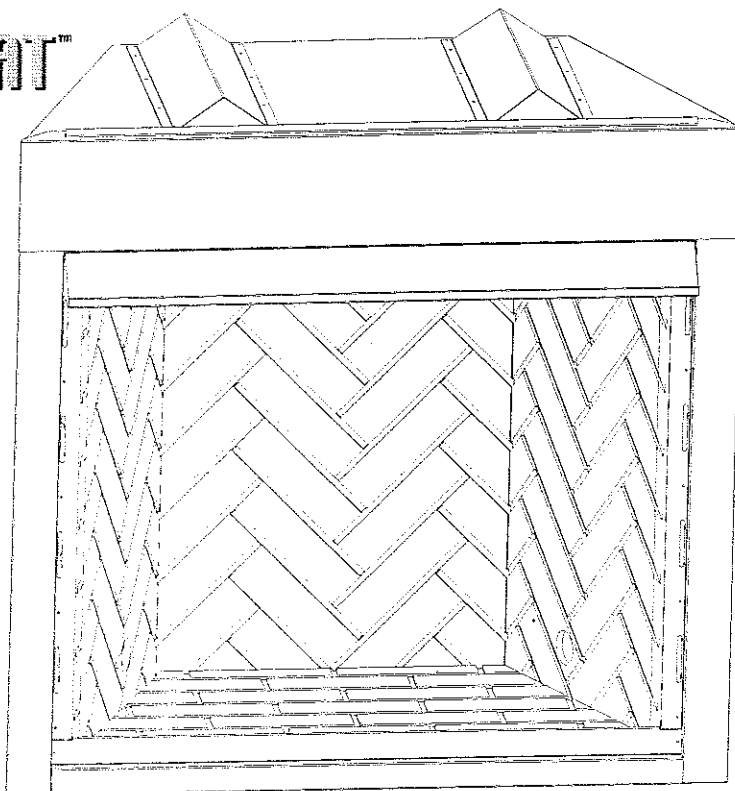
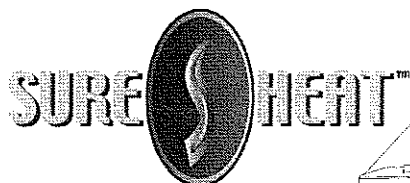

## HOMEOOWNER'S INSTALLATION AND OPERATING MANUAL

FOR USE ONLY WITH A LISTED  
GAS-FIRED UNVENTED  
DECORATIVE ROOM HEATER  
NOT TO EXCEED 40,000 BTU/H.

DO NOT BUILD A WOOD FIRE

Carefully review the instructions supplied  
with decorative type unvented room heater  
for the minimum fireplace size requirements

DO NOT INSTALL AN APPLIANCE IN THIS  
FIREBOX UNLESS THIS FIREBOX MEETS  
THE MINIMUM DIMENSIONS REQUIRED FOR  
THE INSTALLATION

### **⚠ WARNING**

If the information in this manual is not  
followed exactly, a fire or explosion may  
result causing property damage, personal  
injury or loss of life

Installer:

Leave this manual with the appliance.

Consumer:

Retain this manual for future reference.

# CONGRATULATIONS!

## INSTALLER/CONSUMER SAFETY INFORMATION

Read and save these instructions.

This book contains your installation instructions and should be kept in a safe place. For you to realize all the advantages and use of the reliable service that has been engineered into your Sure Heat Manufacturing fireplace, you must carefully follow all of the instructions contained in this book regarding installation and operation of the fireplace.

These instructions should be read carefully in their entirety before beginning installation of the fireplace.

It is suggested that you wear work gloves and safety glasses to protect your hands and eyes when installing your fireplace. NOTE: Authorities having jurisdiction (i.e. building inspectors, fire marshals, etc.) should be consulted before installation to determine the need to obtain a permit.

**These fireboxes are approved as universal fireboxes and can be paired with any ANSI Z21.11.2 approved vent free gas log set. The vent free log manufacturer's instructions, including their required dimensional clearances for firebox size, must be followed.**

Refer to the manual that is packed with the log set for operating instructions.

### General Installation Information

In planning the installation for the appliance it is necessary to determine where the unit is to be installed and whether optional accessories are desired. Gas supply piping should also be planned. The following steps represent the normal sequence of installation. Each installation is unique, however, and might require a different sequence.

1. Position firebox prior to framing or into prepared framing.
2. Plumb gas line. (Gas connections should only be performed by an experienced, licensed/certified tradesman).
3. Install vent-free gas log heater per the instructions provided with the vent-free gas log heater.
4. Complete finish wall material, surround and optional hearth extension to your individual taste.

### Table of Contents

Safety Information .....	.2
Before You Start .....	.5
Hearth Dimensions .....	.6
Fireplace Framing Dimensions .....	.7
Installation Instructions .....	.8-14
Locating the Fireplace .....	.8
Gas Line .....	.8
Drafts .....	.8
Clearances .....	.10
Installing the Firebox .....	.11
Finishing the Fireplace .....	.12
Hearth Extension .....	.13
Install Optional Outside Air Kit .....	.13
Replacement Parts .....	.15
Servicing .....	.15
Warranty .....	.16

# SAFETY INFORMATION

## IMPORTANT

Read these instructions carefully before installing or trying to operate a vent-free gas heater in this firebox.

### **⚠ WARNING**

- Any change to this heater or its controls can be dangerous.
- Improper installation or use of the heater can cause serious injury or death from fire, burns, explosion or carbon monoxide poisoning.
- Do NOT allow fans to blow directly into the fireplace. Avoid any drafts that alter burner flame patterns.

1. Due to high temperatures, the appliance should be located out of traffic and away from furniture and draperies.
2. Children and adults should be alerted to the hazard of high surface temperature and should stay away to avoid burns or clothing ignition.
3. Young children should be carefully supervised when they are in the same room with the appliance.
4. Do not place clothing or other flammable material on or near the appliance.
5. Any safety screen or guard removed for servicing an appliance must be replaced prior to operating the heater.
6. Installation and repair should be done by a qualified service person.
7. To prevent malfunction and/or sooting, an unvented gas heater should be cleaned before use at least annually by a professional service person. More frequent cleaning may be required due to excessive lint from carpeting, bedding material, etc. It is imperative that control compartments, burners and circulating air passages be kept clean.
8. **CARBON MONOXIDE POISONING:** Early signs of carbon monoxide poisoning are similar to the flu with headaches, dizziness and/or nausea. If you have these signs, obtain fresh air immediately. Have the heater serviced as it may not be operating properly.
9. The installation must conform with local codes or, in the absence of local codes, with the **National Fuel Gas Code, ANSI Z223.1/NFPA54.**
10. This unit complies with ANSI Z21.91.2001 ventless firebox enclosures for gas-fired unvented decorative room heaters.
11. Do not install heater in a bathroom or bedroom.
12. Correct installation of the logs, proper location of the heater, and annual cleaning are necessary to avoid potential problems with sooting. Sooting, resulting from improper installation or operation, can settle on surfaces outside the fireplace. See log placement instructions for proper installation.
13. Avoid any drafts that alter burner flame patterns. Do not allow fans to blow directly into fireplace. Do not place a blower inside burn area of firebox. Ceiling fans may create drafts that alter burner flame patterns. Sooting and improper burning will occur.
14. **⚠ CAUTION** Candles, incense oil lamps, etc. produce combustion byproducts including soot. Vent-free appliances will not filter or clean soot produced these types of products. In addition, the smoke and/or aromatics (scents) may be reburnt in the vent-free appliance which can produce odors. It is recommended to minimize the use of candles, incense, etc. while the vent-free appliance is in operation.
15. An unvented gas-fired heater uses air (oxygen) from the room in which it is installed. Provisions for adequate combustion and ventilation air must be provided. See installation guidelines.
16. Keep room area clear and free from combustible materials, gasoline and other flammable vapors and liquids.
17. Unvented gas heaters are a supplemental zone heater. They are not intended to be a primary heating appliance.
18. Unvented gas heaters emit moisture into the living area. In most homes of average construction, this does not pose a problem. In houses of extremely tight construction, additional mechanical ventilation is recommended.

# SAFETY INFORMATION

19. During manufacturing, fabricating and shipping, various components of this appliance are treated with certain oils, films or bonding agents. These chemicals are not harmful but may produce annoying smoke and smells as they are burned off during the initial operation of the appliance, possibly causing headaches, or eye or lung irritation. This is a normal and temporary occurrence.

The initial break-in operation should last two to three hours with the burner at the highest setting. Provide maximum ventilation by opening windows or doors to allow odors to dissipate. Any odors remaining after this initial break-in period will be slight and will disappear with continual use.

20. Input ratings are shown in BTU per hour and are for elevations up to 2,000 feet. For elevations above 2,000 feet, input ratings should be reduced 4% for each 1,000 feet above sea level. Refer to the National Fuel Gas Code.

21. The appliance and its appliance main gas valve must be disconnected from the gas supply piping systems during any pressure testing of that system at test pressures in excess of 1/2 psig (3.5kPa).

22. The appliance must be isolated from the gas supply piping system by closing its equipment shutoff valve during any pressure testing of the gas supply piping system at test pressures equal to or less than 1/2 psig (3.5 kPa).

23. Do not use this room heater if any part has been under water. Immediately call a qualified service technician to inspect the room heater and to replace any part of the control system and any gas control which has been under water.

24. Never burn solid fuels in a fireplace where an unvented room heater is installed.

25. Always have a fireplace screen in place when the appliance is in operation, and unless other provisions for combustion air are provided, the screen shall have an opening(s) for induction of combustion air.

26. Do not fill spaces around the firebox with insulation or other materials. These spaces must be maintained to prevent the firebox from coming in contact with combustible materials.

# BEFORE YOU START

## **⚠ WARNING**

Do not attempt to burn solid wood fuels, vented gas log sets, or any other combustible in this unvented firebox. Also, do not install a vent-free gas log set in this firebox if the minimum clearance and height requirements of the log set are too large for the firebox.

You have purchased a vent-free firebox. This installation manual will enable you to obtain a safe, efficient and dependable installation of your vent-free firebox system.

Do not alter or modify the firebox or its components under any circumstances. Any modifications or alteration of the firebox system, including but not limited to the firebox and accessories, may void the warranty, listings and approvals of this system, and could result in an unsafe and potentially dangerous installation.

## **Before You Start**

Carefully inspect the contents for shipping damage. If any parts are missing or damaged, immediately inform the dealer from whom you purchased the appliance. Do not attempt to install any part of the appliance unless you have all the parts in good condition.

## **Make Sure That You Have Received All Parts**

Check your packing list to verify that all listed parts have been received. You should have the following:

1. Vent-Free Gas Firebox
2. Canopy
3. Installation and Operating Manual
4. Five (5) sheet metal screws for canopy.

## **What You Will Need For Installation**

### **Tools**

- Phillips screwdriver
- Hammer
- Tee Joint
- Level
- Measuring Tape
- Pliers

- Square
- Saw and/or sabersaw
- Electric drill and bits
- Pipe wrench
- Piping complying with local codes
- Pipe sealant approved for use with propane/L.P.G. (resistant to sulfur compounds)

### **Building Supplies**

- Framing materials
- Wall finishing materials
- Caulking material (non-combustible)
- Fireplace surround materials (non-combustible)

### **Notice:**

Illustrations shown in this manual reflect "typical" installations with nominal dimensions and are for design and framing reference only. Actual installations may vary due to individual design preferences. However, always maintain minimum clearances to combustible materials and do not violate any specific installation requirements.

# SPECIFICATIONS

VFLB 32, VFLB 36, VFLB 42 Certified To
Design Certified  
Certified To IAS 2-97 Ventless Firebox Enclosures For Gas Fired Decorative Type Unvented Room Heaters
For use with Any ANSI Z21.11.2 Unvented Room Heaters

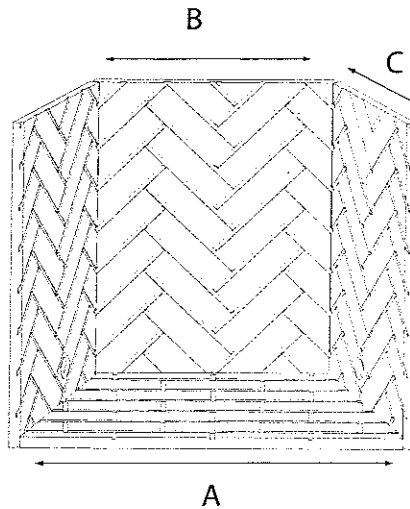

Fig. 1: Firebox  
Internal  
Dimensions

### Hearth Dimensions

MODEL	Front Width (Brick to Brick) A	Back Width (Back to Brick) B	Hearth Depth C
VFLB32	29.5" (749 mm)	16" (406 mm)	17" (432mm)
VFLB36	33.5" (851 mm)	20" (507 mm)	17" (432mm)
VFLB42	39.5" (1002 mm)	26" (660 mm)	17" (432mm)

# FRAMING SPECIFICATIONS

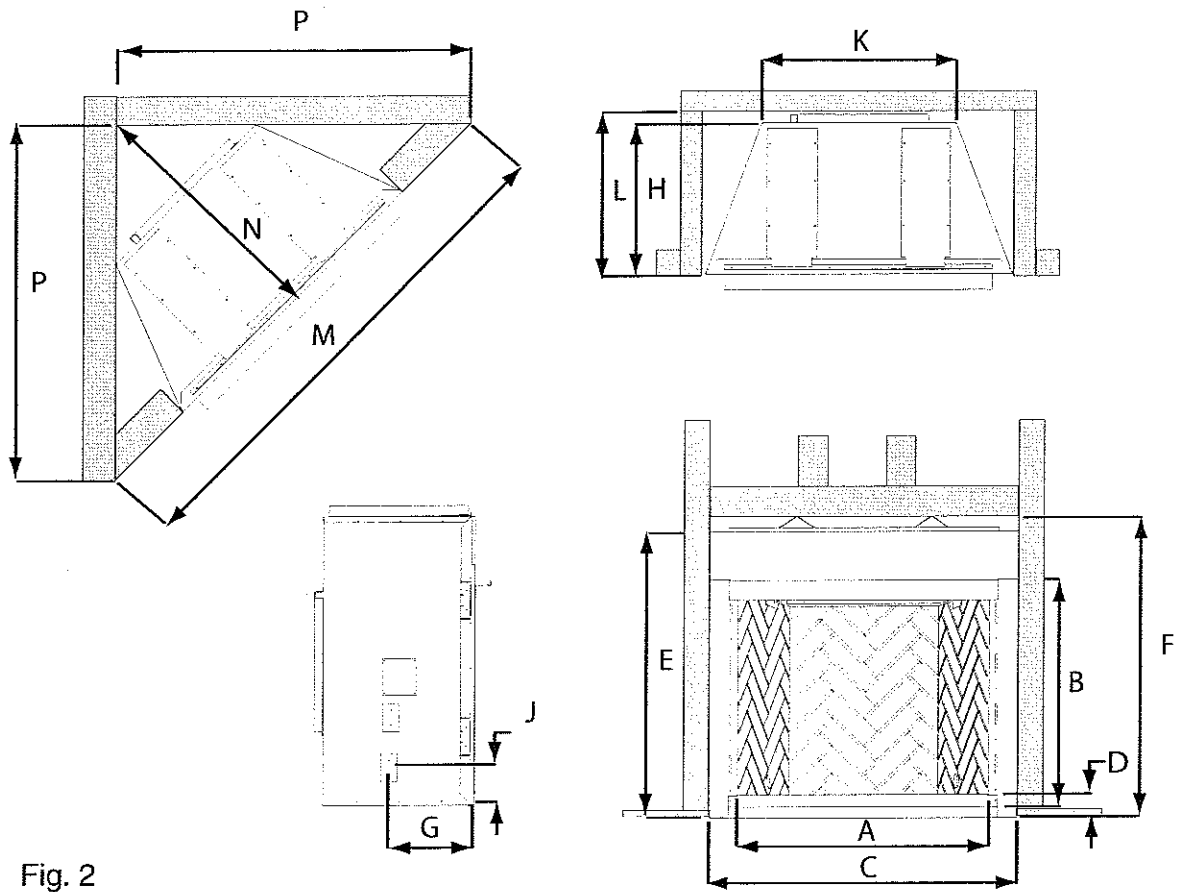

Fig. 2

	VFLB 32	VFLB 36	VFLB 42
A	32"	36"	42"
B	30"	30"	30"
C	37"	41"	47"
D	3"	3"	3"
E	38"	38"	38"
F	40.15"	40.15"	40.15"
G	11.35"	11.35"	11.35"
H	20"	20"	20"
J	5"	5"	5"
K	22"	26"	32"
L	21.5"	21.5"	21.5"
M	62.5"	66.5"	72.5"
N	31.25"	33.25"	36.25"
P	44"	47"	51.25"

# INSTALLATION AND INSTRUCTIONS

## Locating the Fireplace

Figure 3 shows some of the many ways your fireplace may be installed. Consider the traffic pattern in your room and the location of doors and windows. Moving air from ceiling fans, open doors and hot air grills may cause the flames to soot. If a disturbance is found that affects the flames, it must be eliminated by turning off the ceiling fan, closing the door or closing or moving the hot register. A corner location may be best where space is limited.

Your fireplace weighs no more than some of your fine furniture. If the fireplace is located near a load bearing wall, additional supports to the foundation will not be necessary.

HEAVY FACINGS SUCH AS BRICK, STONE, ETC., MAY REQUIRE ADDITIONAL FOUNDATION SUPPORT. ALTHOUGH THIS UNIT MAY BE INSTALLED ON COMBUSTIBLE SURFACES, IT MUST NOT BE INSTALLED ON CARPET OR VINYL.

## Gas Line Installation

**⚠ WARNING** Plumbing connection should only be performed by a qualified, licensed plumber. Main gas supply must be off when plumbing gas line to fireplace or performing service

Consult all local codes. All gas piping must be installed to comply with local codes, or in the absence of local codes, with the latest edition of the national Fuel Gas Code ANSI Z223.1/NFPA54.

The ½" gas line may enter either from the left side or the right side of the firebox. Gas access holes are provided on both sides of the firebox.

Install a ½" gas line through the hole provided in the firebox. Outside the firebox, the gas line connects to a gas shut-off valve recessed flush into the wall or floor. The valve should be controlled by a removable valve key for safety.

An ANSI approved manual shut-off valve, union and plugged ½" NPT pressure tapping point must be installed upstream of the heater.

A sediment trap may be upstream of the heater to prevent moisture and contaminants from passing through trap to the heater controls and burners. Failure to do so could prevent the heater from operating reliably. Consult applicable codes.

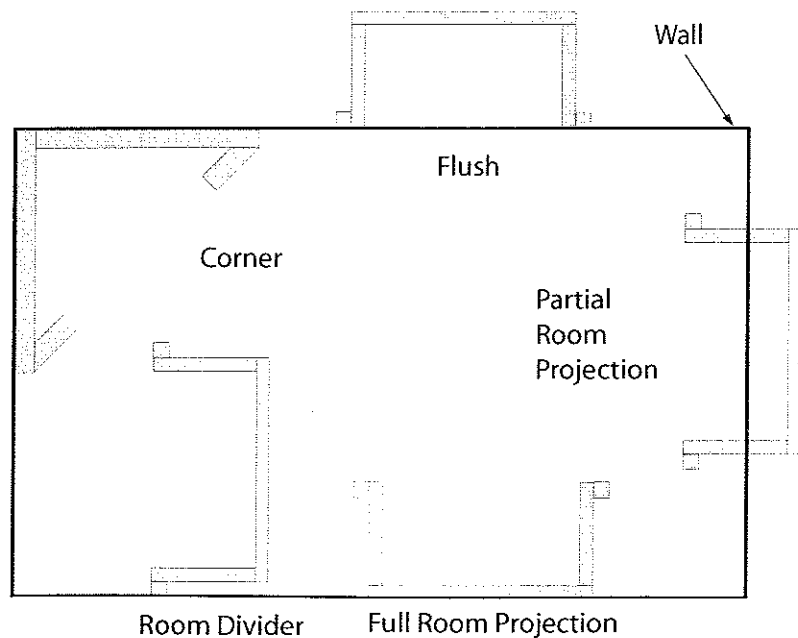

Fig. 3: Locating the Fireplace

# INSTALLATION AND INSTRUCTIONS

An external regulator must be used on all propane/L.P.G. heaters, in addition to the regulator fitted to the heater, to reduce the supply tank pressure to 13" w.c. (maximum). Any copper tubing used to supply propane/L.P.G. from the tank must be internally tinned.

NOTE: When connecting propane/L.P.G. vent-free room heaters, you must use pipe sealant resistant to propane/L.P.G.

IMPORTANT: Hold heater regulator with a wrench to prevent movement when connecting to inlet piping.

Check Gas Type: The gas supply must be the same as stated on the heater's rating plate. If the gas supply is different, DO NOT INSTALL THE HEATER. Contact our dealer for the correct model.

**⚠ WARNING** Connecting directly to an unregulated propane/L.P.G. tank can cause an explosion.

After completing connection, test all gas joints from the gas meter to the gas heater regulator for leaks. Using water soap and water solution or a gas sniffer. DO NOT USE AN OPEN FLAME.

**⚠ WARNING** Do not connect directly to natural gas 1/2 PSI or 2 PSI systems. Always make sure natural gas pressure is regulated 10.5 w.c. (maximum before operating unit).

## Drafts

Do not locate the fireplace in high traffic areas or areas exposed to high drafts and winds. Locate the fireplace away from furniture and draperies.

## Fireplace Clearances

The fireplace may be placed directly on a combustible floor, against a combustible wall at marked clearances or on a raised wooden platform.

If the fireplace is to be installed on a raised wooden platform, the platform must be a continuous level surface. The fireplace must be secured in place so it cannot shift positions. The nailing flanges on the sides of the firebox make securing it to the framing easy. They were designed to allow the installation of wallboard or plywood flush with the face of the fireplace.

Only the header (Fig. 2, page 7) may rest on the standoffs on top of the firebox.

When the fireplace is installed over carpeting, vinyl, tile or any combustible material other than wood flooring, it must be installed on a metal or wood panel extending its full width and depth. Alternatively, the carpeting, vinyl, tile, etc., may be removed from beneath the fireplace before installing.

COMBUSTIBLE MATERIALS MUST NOT BE INSTALLED OVER OR TOUCH ANY BLACK PAINTED SURFACE.

# INSTALLATION AND INSTRUCTIONS

## Clearances

To ensure a safe installation the following instructions must be carefully observed.

1. **Sidewall Clearances:** Clearances from the side of the fireplace opening to any combustible wall should not be less than 9".
2. **Ceiling Clearances:** The ceiling height should not be less than 42" from the top of the fireplace opening.

### 3. Mantel Clearances:

- a) Noncombustible materials used in this installation such as slate, marble, tile, etc. must comply with local, state, national codes and manufactures specifications. Do not install a combustible material behind sheet metal. Failure to use noncombustible materials above the opening as specified in these instructions may cause damage to the materials used and create a fire hazard.

- b) A heat reducing mantel guard is shipped with the fireplace. Use of this mantel guard is required in order to reduce mantel heights as shown in figure 6. When the mantel guard is installed, a combustible mantel piece may project 2" from the wall at 6" above the fireplace opening. A 6" mantel projection at 13" above the fireplace opening and a 10" projection at 22" above the opening. (Fig 4 and 7)

- c) If the fireplace has no mantelpiece, then the heat resistant material must extend upwards a distance of at least 9" from the fireplace opening. A mantel projection must be a minimum of 24" above the top fireplace opening if a mantel guard is not installed. (Fig. 4 and 5)

To install the required mantel guard you will need a Flathead screwdriver. The mantel guard has seven holes along the top edge. There will already be screws in three of the holes. Line up slots in Mantel Guard with holes in the upper channel (top front edge) of the firebox. The mantel guard will fit tightly in the top front edge of the fireplace opening. Attach the mantel guard with the four sheet metal screws provided.

**⚠ WARNING** The required firebox canopy (mantel guard) supplied with this unit from Sure Heat (the manufacturer) must not be modified or replaced with a canopy (mantel guard) that/which may be provide by the manufacture or supplier of the decorative room heater.

- 1) **Floor Clearances:** No clearance is required if the appliance is installed per these instructions.

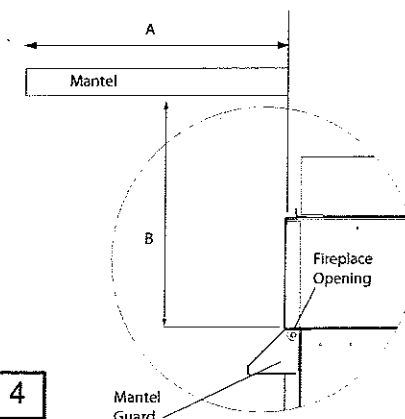

Fig. 4

Clearance to Combustible Mantel with Mantel Guard not in place.

Mantel Depth (A)	2"	4"	6"	8"	10"
Clearance Fireplace Opening (B)	11"	13"	16"	20"	24"

Fig. 5 Chart

Clearance to Combustible Mantel with Mantel Guard in place.

Mantel Depth (A)	2"	4"	6"	8"	10"
Clearance Fireplace Opening (B)	6.5"	10"	13"	17"	22"

Fig. 6 Chart

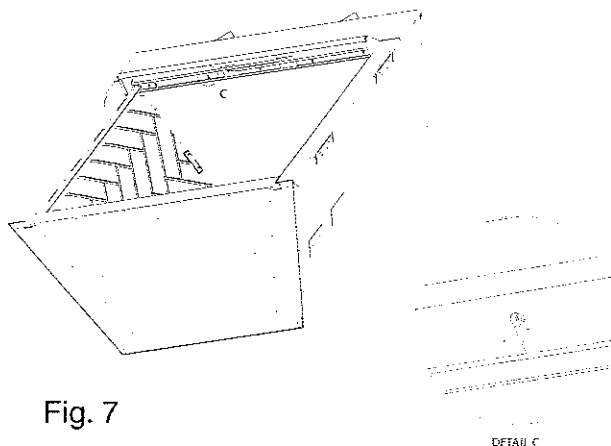

Fig. 7

# INSTALLATION AND INSTRUCTIONS

## Installing the Firebox

Installation must conform with local codes, or in the absence of local codes, with the National Fuel Gas Code, ANSI Z223.1/NFPA 54.

This list of specific instructions will help you make certain that every installation operation is done correctly. Complete the installation steps in the sequence shown.

LOCAL BUILDING CODES SHOULD BE CONSULTED IN ALL CASES AS TO THE PARTICULAR REQUIREMENTS CONCERNING THE INSTALLATION OF FACTORY BUILT FIREPLACES.

Select the location for the fireplace by taking into consideration the factors previously outlined in the Locating the Fireplace section of this manual.

### Step 1: Framing the Firebox

The width of the framed openings must be 37" for 32" models, 41" for 36" models or 47" for 42" models. (Fig. 2, page 7)

The entire fireplace can be elevated above the floor to achieve a raised hearth effect. This can be done by adding a small platform to achieve the desired height.

### Step 2: Install the Firebox

Install the firebox into the framed opening by setting it directly in front of the opening and sliding it into the proper position.

### Step 3: Level the Firebox

Check the level of the firebox on the top edge of the fireplace face. Shim if necessary.

### Step 4: Secure the Firebox

Four (4) nailing flanges are supplied with the fireplace to level the box and secure firmly in place; Bend the nailing flanges from the sides of the fireplace as shown in Figure 8.

Note: The nailing flanges have two (2) sets of holes to allow for adjustment for 1/2" or 5/8" offset of the face of the unit. When installing the nailing flanges, choose the set of holes on the nailing flange that fit with your application.

**Note: This firebox employs spacers, stand offs and nailing flanges to inhibit contact of parts of the firebox with combustible construction .**

**⚠ WARNING** do not alter the spacers or divert from their intended use or notch the framing in any manner.

### Step 5: Gas Piping and Connection

The gas piping must be installed in accordance with local codes or, in the absence of local codes, in accordance with the National Fuel Gas Code, ANSI Z223.1/NFPA 54, latest edition.

Piping should be tested for leaks prior to final wall installation. Test for leaks, using a soap and water solution or any acceptable solution or mechanical gas leak detector, after completing the connection. **DO NOT USE OPEN FLAME.**

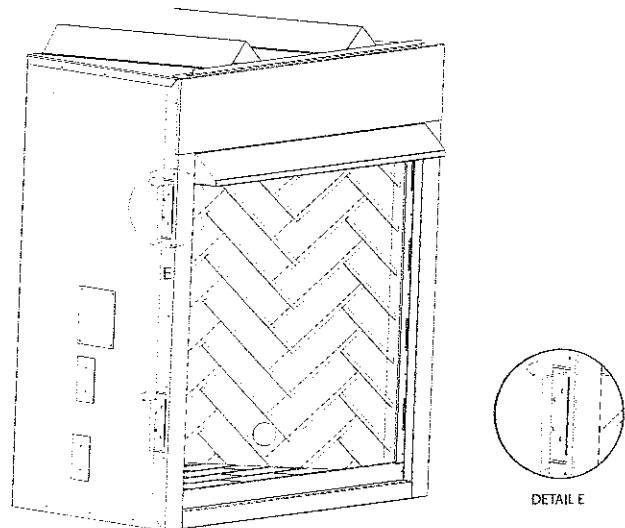

Fig. 8

# INSTALLATION AND INSTRUCTIONS

## Step 6: Optional Procedure for Cold Climate Installations

The insulation and sealing of the enclosure around the fireplace is very important in cold climates. If the enclosure is insulated and sealed properly, you can avoid future cold air problems. The time taken to install the firebox correctly is well worthwhile. The following steps are to stop potential cold air problems. (Do not use Kraft Faced insulation - paper faced)

### Insulation of the Fireplace Enclosure

When in a chase or an outside wall, the fireplace enclosure should be insulated like any other wall of your home. Insulation should be installed on the outside wall(s) and the wall about the fireplace. (Do not use Kraft Faced insulation - paper faced.)

### Insulate to Seal Under the Fireplace

Insulating under the fireplace is beneficial for installations on a concrete slab in cold weather climates. The fireplace should be placed on insulating board. It is important that a hard, rigid surface be maintained, so do not use fiberglass insulation for this purpose.

**⚠ CAUTION** WHEN INSTALLING A FIREPLACE IN AN INSULATED ENCLOSURE, BE SURE TO MAINTAIN ALL MARKED AIR SPACES. DO NOT USE KRAFT (PAPER FACED) INSULATION .

### Seal Seams

Sealing the seams of the fireplace is beneficial for installations in cold weather climates where the outer wall meets the bottom pan and the front face. Also seal between the fireplace and finishing materials. Use **high temperature** caulk. Refer to Figure 9 for details of sealing spaces between the fireplace and finishing materials.

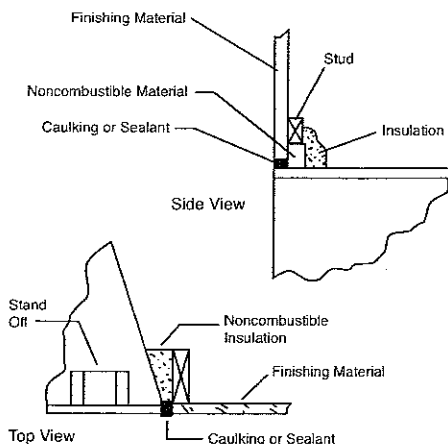

Fig. 9

## Finishing the Fireplace

There are a wide variety of finishing materials available for your fireplace from formal wall treatments with marble and mantles to rustic wood paneling, stone or brick.

IT IS IMPORTANT THAT THE BLACK FACE OF THE FIREPLACE NOT BE COVERED WITH ANY TYPE OF COMBUSTIBLE MATERIAL.

Noncombustible facing materials such as marble, brick or ceramic tile may overlap the black face of the fireplace up to the opening on either side of the fireplace. Seal all joints between the black fireplace face and the wall covering with a heat-resistant material such as rock wool insulation or mortar. Be sure to use high temperature adhesive or mortar when anchoring brick, stone or tile to the face of the fireplace. Check to see whether man-made brick and stone are made of noncombustible materials before using them on the face of the fireplace. Some of these products contain combustible materials. Combustible wall coverings such as paneling or wallboard may not overlap the black face of the fireplace. The space between the wall covering and the fireplace should be sealed with a heat-resistant material such as rock wool insulation or mortar.

NOTE: An "L" shaped steel lintel must be installed across the top of the firebox opening where facing materials such as brick or stone are used on the face of the firebox. It acts as a support/firestop. It should be attached to the face of the fireplace with screws and sealed to the fireplace with a heat-resistant sealer.

**⚠ WARNING** These vent free fireplaces are not to be used with any TYPE or MODEL of glass doors.

**⚠ WARNING** Fireplace screens must be in the closed position across the entire hearth opening prior to the operation of the decorative room heater.

NOTE: Information on provisions for adequate combustion and ventilation air are located in the unvented room heaters installation instructions.

# INSTALLATION AND INSTRUCTIONS

## Hearth Extension

An optional hearth extension may be used, but is not required for these fireboxes.

A raised hearth extension may be used as shown in Figure 10.

## Install Optional Outside Air Kit

The VAK1 Outside Air Kit can be installed to bring combustion air to the heated room air. The air drawn into the heated room air from outside the home or unheated area helps relieve the pressure in the home. The duct termination should be located so it is exposed to an out-of-doors opening of at least 100 square inches. If the duct termination must be located in a crawl space or basement, be sure the termination area has 100 square inches of ventilation opening to outside air.

The duct termination must be located so it does not compete for air flow with exhaust fans, gas vent hoods or other air consuming devices or appliances. It must not be obstructed by rafters, insulation materials or other obstructions. The less restrictive the air supply, the better the outside air kits will perform.

It is good practice to protect your hands and eyes during installation by wearing work gloves and safety glasses.

**⚠ WARNING** Do not install termination into a garage or other area that could contain flammable liquids or fumes, into a confined attic space or non ventilated soffit .

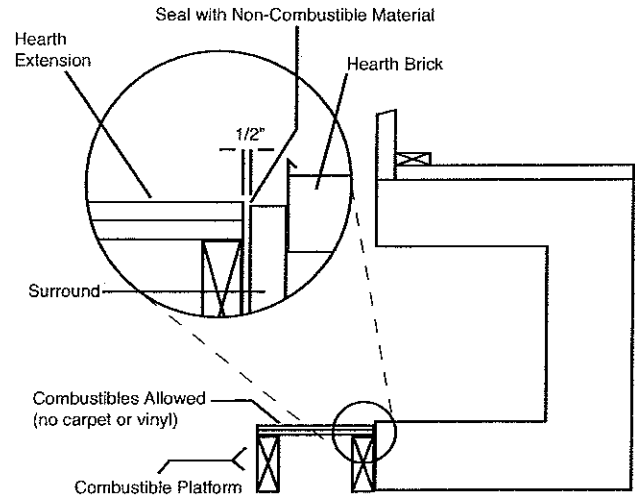

Fig. 10

# INSTALLATION AND INSTRUCTIONS

## Installation Instructions

Determine the location of the fireplace as described in the fireplace installation manual. Then plan the location of the duct termination and the route of the duct run between the fireplace and the duct termination.

Duct run must be limited to a maximum distance of 40' (12.2m) from the fireplace pipe collar to duct termination. This will provide the least restriction to air flow. No more than four (4) 90° elbows can be used. Duct run may be horizontal, vertical, inclined or any combination of these. (Fig. 11) You are now ready to install the Outside Air Kit.

1. Remove the screws retaining the outside air coverplate, if provided. (Located on the left side of front open units, on backside of multi-sided units.) Discard coverplate. (Fig. 12)
2. Secure the inlet collar assembly to the outer casing with four screws (screws not provided).
3. Slide the duct over the collar and attach the duct to the collar using the plastic tie straps or three (3) screws (screws not provided). Continue attaching the ducting together using three (3) screws at each joint until you have installed sufficient duct to arrive at your duct termination locations.
4. At the termination end, install the duct termination. This should be installed from the outside of the home. Cut a hole in the desired location approximately 4" in diameter, caulk around the hole, and slide the termination through the opening from outside the home. The termination/rain cap should be caulked around its perimeter to assure a tight seal. The rain cap opening should be positioned downward.

The Outside Air Kit is now installed and ready for use.

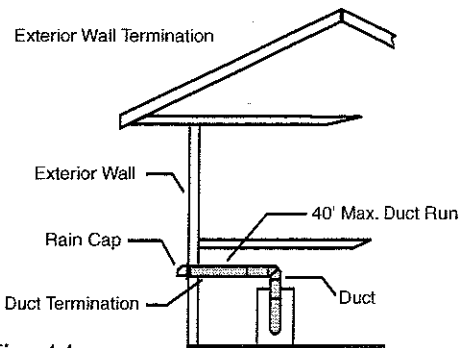
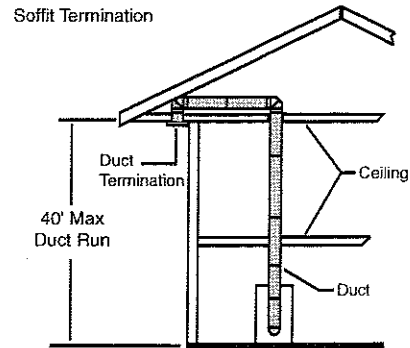

Fig. 11

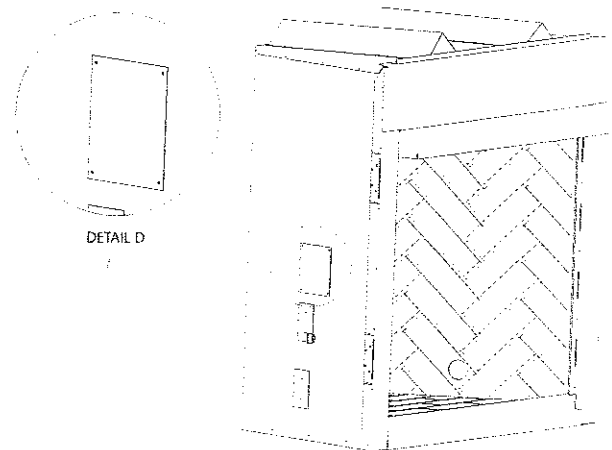
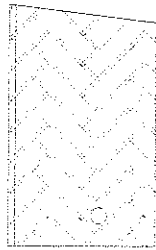
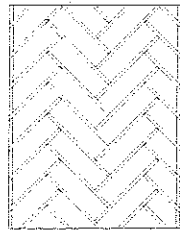

Fig. 12

# PARTS AND SERVICING



1



2

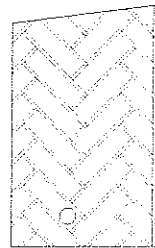

3

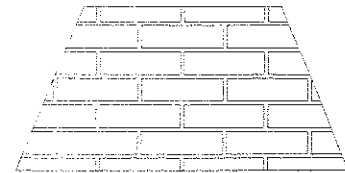

4

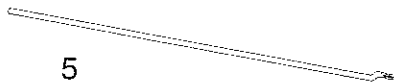

5

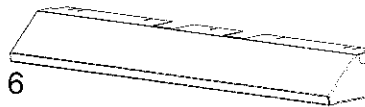

6

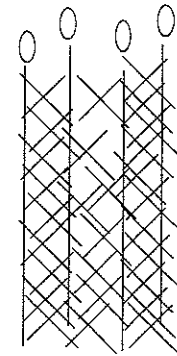

7

8 is not pictured

		VFLB32	VFLB36	VFLB42
1	Firebrick Left	21321101	21361101	21421101
2	Firebrick Middle	23321201	23361201	23421201
3	Firebrick Right	21321301	21361301	21421301
4	Firebrick Bottom	21321401	21361401	21421401
5	Screen Mesh Wire	20321301	20361301	20421301
6	Mantel Guard	21321401	21361401	21421401
7	Screen Mesh	21322001	21362001	21422001
8	Outside Air Kit	20005001	20005001	20005001

Contact Sure Heat Manufacturing for questions concerning prices and policies covering replacement parts. Parts may be ordered through your Sure Heat distributor or dealer.

You will need the correct name, part number and model number of the appliance when ordering replacement parts.

Should you need additional information beyond what your dealer can furnish, contact:

Sure Heat Manufacturing  
3130 Moon Station Road  
Kennesaw, GA 30144  
(800) 229-5647

## Servicing

Repair and replacement work should only be done by a qualified service person.

Always shut off the gas supply and make sure the appliance is cool before beginning any service operation.

Always check for gas leaks after servicing.

[www.sureheat.com](http://www.sureheat.com)

# LIMITED LIFETIME WARRANTY

**Limited Warranty shall apply to the original purchaser at the original installation point only**

The following components are warranted for life to the original owner, subject of proof of purchase: Firebox, Combustion Chamber, Heat Exchanger.

**General Warranty:** This Limited Lifetime Warranty will be void if the appliance is not installed by a qualified installer in accordance with the installation instructions. The Limited Lifetime Warranty will also be void if the appliance is not operated and maintained according to the operating instructions supplied with the appliance, and does not extend to (1) firebox assembly damage by accident, neglect, misuse, abuse, alteration, negligence of others, including the installation thereof by unqualified installers, (2) the costs of removal, reinstallation or transportation of defective parts on the appliance, or (3) incidental or consequential damage. All service work must be performed by an authorized service representative.

This warranty is expressly in lieu of other warranties, express or implied, including the warranty of the merchantability of fitness for the purpose and of all other obligations or liabilities. Sure Heat Mfg. Co. does not assume for it any other obligations or liabilities in connection with the sale or use of the appliance. In states that do not allow limitation on how long an implied warranty lasts, or do not allow exclusion of indirect damage, those limitations of exclusions may not apply to you. You may also have the additional rights not covered in this Limited Lifetime Warranty.

Sure Heat Mfg. Co. reserves the right to investigate any and all claims against the Limited Lifetime Warranty and decide upon method of settlement.

All costs for removal and reinstallation are the expressed responsibility of the purchaser.

For repair or replacement of a defective part or parts, contact our customer service department at 1-800-229-5647. You will be asked to provide valid warranty registration, proof of purchase and model number.

Purchased From: \_\_\_\_\_ Date: \_\_\_\_\_

Size:     VFLB32         VFLB36         VFLB42

Name \_\_\_\_\_ Date: \_\_\_\_\_ Phone (    ) \_\_\_\_\_

Address \_\_\_\_\_

City \_\_\_\_\_ State \_\_\_\_\_ Zip \_\_\_\_\_

E-mail \_\_\_\_\_

If you have other questions, please contact Customer Service Hotline

(800) 229-5647